





# PUBLIC ROADS

A JOURNAL OF HIGHWAY RESEARCH



UNITED STATES DEPARTMENT OF AGRICULTURE  
BUREAU OF PUBLIC ROADS



VOL. 18, NO. 8



OCTOBER 1937

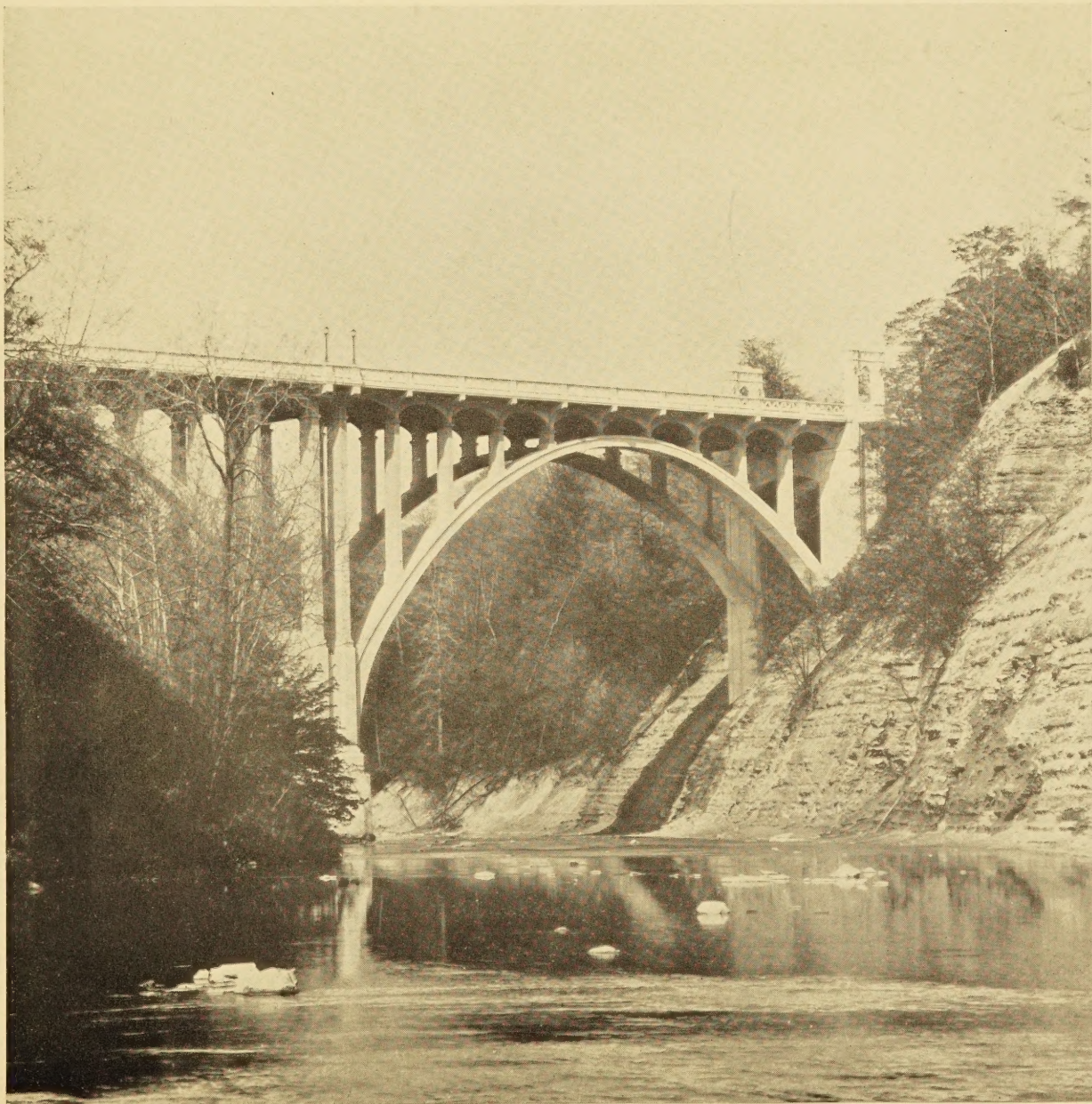

REINFORCED CONCRETE ARCH BRIDGE IN OHIO

---

---

# PUBLIC ROADS

▶▶▶ *A Journal of  
Highway Research*

*Issued by the*

UNITED STATES DEPARTMENT OF AGRICULTURE  
BUREAU OF PUBLIC ROADS

Volume 18, No. 8

October 1937

---

*The reports of research published in this magazine are necessarily qualified by the conditions of the tests from which the data are obtained. Whenever it is deemed possible to do so, generalizations are drawn from the results of the tests; and, unless this is done, the conclusions formulated must be considered as specifically pertinent only to described conditions.*

## *In This Issue*

	Page
Distribution of Wheel Loads and Design of Reinforced Concrete Bridge Floor Slabs . . . . .	149

THE BUREAU OF PUBLIC ROADS - - - - - Willard Building, Washington, D. C.  
REGIONAL HEADQUARTERS - - - - - Federal Building, Civic Center, San Francisco, Calif.

▼

### DISTRICT OFFICES

- |   |   |
|---|---|
| DISTRICT No. 1. Oregon, Washington, and Montana.<br>Post Office Building, Portland, Oreg.                                   | DISTRICT No. 8. Alabama, Georgia, Florida, Mississippi, and Tennessee.<br>Post Office Building, Montgomery, Ala.  |
| DISTRICT No. 2. California, Arizona, and Nevada.<br>Federal Building, Civic Center, San Francisco, Calif.                   | DISTRICT No. 9. Connecticut, Maine, Massachusetts, New Hampshire, New Jersey, New York, Rhode Island, and Vermont.<br>505 Post Office Building, Albany, N. Y. |
| DISTRICT No. 3. Colorado, New Mexico, and Wyoming.<br>254 New Customhouse, Denver, Colo.                                    | DISTRICT No. 10. Delaware, Maryland, Ohio, Pennsylvania, and District of Columbia.<br>Willard Building, Washington, D. C.                                     |
| DISTRICT No. 4. Minnesota, North Dakota, South Dakota, and Wisconsin.<br>907 Post Office Building, St. Paul, Minn.          | DISTRICT No. 11. Alaska.<br>Room 419, Federal and Territorial Building, Juneau, Alaska.   |
| DISTRICT No. 5. Iowa, Kansas, Missouri, and Nebraska.<br>Masonic Temple Building, Nineteenth and Douglas Sts., Omaha, Nebr. | DISTRICT No. 12. Idaho and Utah.<br>Federal Building, Ogden, Utah.  |
| DISTRICT No. 6. Arkansas, Louisiana, Oklahoma, and Texas.<br>Room 502, United States Court House, Fort Worth, Tex.          | DISTRICT No. 14. North Carolina, South Carolina, Virginia, and West Virginia.<br>Montgomery Building, Spartanburg, S. C.                                      |
| DISTRICT No. 7. Illinois, Indiana, Kentucky, and Michigan.<br>South Chicago Post Office Building, Chicago, Ill.             |   |

---

Because of the necessarily limited edition of this publication it is impossible to distribute it free to any person or institutions other than State and county officials actually engaged in planning or constructing public highways, instructors in highway engineering, and periodicals upon an exchange basis. At the present time additions to the free mailing list can be made only as vacancies occur. Those desiring to obtain PUBLIC ROADS can do so by sending \$1 per year (foreign subscription \$1.50), or 10 cents per single copy, to the Superintendent of Documents, United States Government Printing Office, Washington, D. C.

# DISTRIBUTION OF WHEEL LOADS AND DESIGN OF REINFORCED CONCRETE BRIDGE FLOOR SLABS

Reported by H. R. ERPS and A. L. GOOGINS, Associate Highway Bridge Engineers, and J. L. PARKER, Highway Bridge Engineer, Bureau of Public Roads

SLABS for highway bridges are designed to support wheel loads in addition to the distributed dead loads. The methods now in use for estimating the influence of distributed dead loads are considered sufficiently accurate and will not be discussed in this study. The problem of stresses in slabs contributed by wheel loads is discussed in a paper, "Computation of Stresses in Bridge Slabs Due to Wheel Loads," by H. M. Westergaard, published in the March 1930 issue of PUBLIC ROADS.

In order to simplify design computations and provide for certain conditions not covered by the Westergaard formulas, there are advanced in this analysis formulas that are a modification of the Westergaard formulas. These formulas give results nearly the same as those proposed by Dr. Westergaard and will be referred to as the modified formulas.

Many of the formulas included in this paper were first developed by the late E. J. Budge, Associate Highway Bridge Engineer, Bureau of Public Roads.

Before any bridge floor slab can be designed, the type of live load and its manner of application must first be known or determined. The truck loading shown in figure 1 represents the loading considered in the subsequent analysis and design of reinforced concrete bridge floor slabs. This loading is the same as that shown in the Standard Specifications for Highway Bridges of the American Association of State Highway Officials, 1935, except that each wheel load is assumed to be applied to the slab over a circular area.

Two types of slabs will be considered, differing in the manner in which they are reinforced as follows:

Case I.—Slabs with main reinforcement parallel to the direction of traffic.

Case II.—Slabs with main reinforcement transverse to the direction of traffic.

The Westergaard investigation did not consider the effect of reinforcement, but was based on homogeneous and isotropic slabs, and the above and subsequent references to reinforcement under cases I and II are merely for the purpose of indicating the direction of the slab spans and the position of wheel loads on these spans.

When considering slabs with reinforcement parallel to the direction of traffic, the position of truck loading, for maximum moment, would be with the rear wheels on the center line of the slab for all spans less than 26.5 feet. This study is limited to spans from 2 to 25 feet, so the critical position of load will be with rear wheels on the center line of the slab.

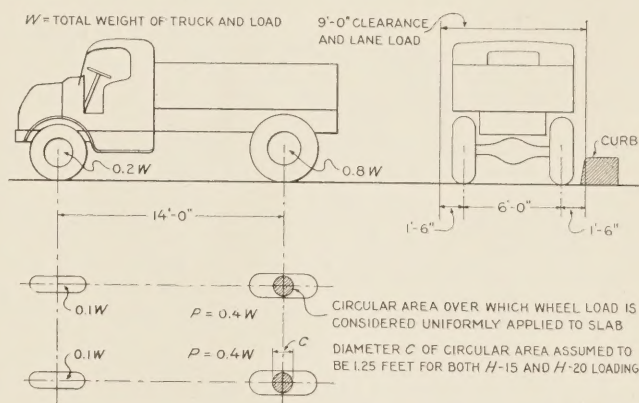

FIGURE 1.—DIAGRAM OF TRUCK LOADING.

When considering slabs with reinforcement transverse to the direction of traffic, the study will be limited to slabs with spans from 2 to 10 feet. With slab spans of such lengths, the required roadway width is obtained by placing several slab spans together, so that there will be interior and exterior spans. On exterior spans, the maximum moment per foot width of slab will be produced by one rear wheel on the center line of the slab, because two wheels at 6-foot centers cannot be placed in position to give a greater moment on spans of less than 10.25 feet. On interior spans, the maximum moment per foot width of slab for the assumed loading will be produced by one rear wheel on the center line of the slab for spans less than 5.14 feet and by two wheels at 3-foot centers placed in position for maximum moment on spans from 5.14 to 10.25 feet.

## Part 1.—WESTERGAARD FORMULAS

The following Westergaard formulas for determining the live load bending moments in slabs were used to develop the modified formulas advanced in this analysis.

*Slabs freely supported.*—For slabs freely supported, the moment for one wheel on the center line of the slab (the center line of the slab is a line at the center of the slab span and parallel to the supports) is as follows:

$$M_{0z} = \frac{PS}{2.32S + 8C} \text{--- Equation (66)}^1$$

$M_{0z}$  = maximum moment, in foot-pounds per foot of width on the center line of a freely supported

<sup>1</sup> Equation numbers refer to those given in the article "Computation of Stresses in Bridge Slabs Due to Wheel Loads", by H. M. Westergaard, PUBLIC ROADS, vol. 11, no. 1, March 1930. The symbols  $s$  and  $c$ , given in lower case in the Westergaard article, have been changed to  $S$  and  $C$ , respectively, in this report.

slab, produced by a single load  $P$  on the center line of slab.

$P$ =wheel load in pounds.

$S$ =effective design span of slab in feet.

$C$ =diameter of circle over which load  $P$  is considered uniformly applied to slab (to be taken as 1.25 feet for this study).

Moment for two or more wheels on the center line of freely supported slabs is considered next. Equation (66) gives the moment  $M_{0x}$  produced by one load  $P$  on the center line of the slab. If a second load,  $P_1$ , is placed on the center line of the slab at a distance  $y$  in feet from load  $P$ , the maximum moment per foot width of slab at load  $P$  will be  $M_{0x} + M_x$ .

$$M_x = 0.21072 P_1 \log_{10} \coth \frac{\pi y}{2S} \pm \frac{0.2125 P_1 y}{S \sinh \frac{\pi y}{S}} \text{---Equation (74)}$$

$M_x$ =the increase in moment  $M_{0x}$  caused by an additional load on the center line of slab at distance  $y$  from  $P$ .

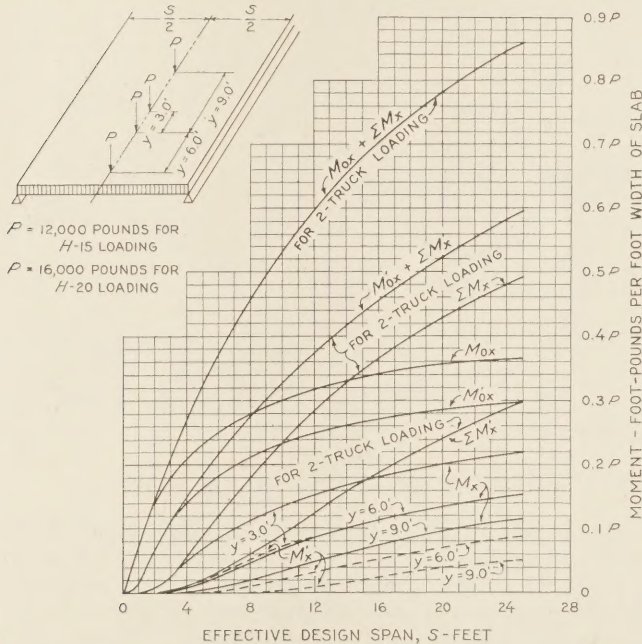

FIGURE 2.—BENDING MOMENTS PRODUCED BY TRUCK LOADINGS, FOR SLABS HAVING MAIN REINFORCEMENT PARALLEL TO THE DIRECTION OF TRAFFIC (CASE I). (VALUES OF  $M_{0x}$  AND  $M'_{0x}$  FOR CASE II ARE THE SAME AS FOR CASE I.)

When considering slabs with reinforcement parallel to the direction of traffic, the number of loads that can be placed on the center line of the slab depends on the width of roadway. When more than two loads are placed on the center line of the slab, the maximum moment per foot width of slab will be  $M_{0x} + \Sigma M_x$ . For slabs of less than 25-foot span, loads whose  $y$  distance from  $P$  is more than 9 feet produce very small values of  $M_x$ . Therefore, for computing the maximum moment per foot width of slab, two trucks will be considered sufficient for all widths of roadway.

The maximum moment for two wheels placed in the direction of the span on freely supported slabs is as follows:

$M_{0x} + \Delta M_x$ =maximum moment per foot width of slab.

$$\frac{\Delta M_x}{P} = 0.21072 \log_{10} \frac{\cot \frac{\pi a}{4S}}{2} \text{---Equation (72)}$$

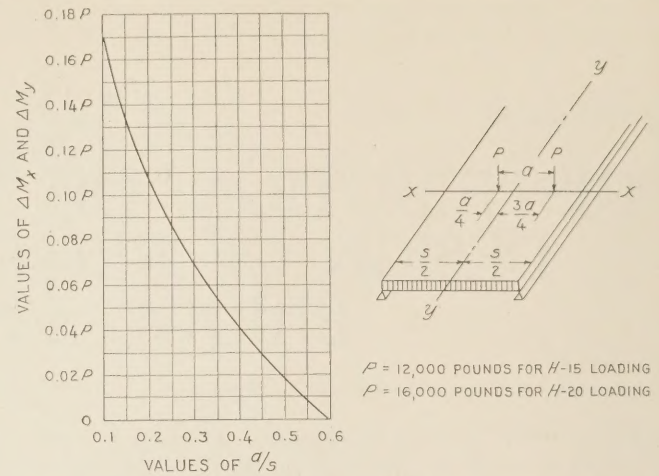

FIGURE 3.—CURVE SHOWING VALUES OF  $\Delta M_x$  AND  $\Delta M_y$  TO BE ADDED TO  $M_{0x}$  OR  $M_{0y}$  TO OBTAIN THE VALUES OF  $M_x$  OR  $M_y$  DUE TO THE COMBINED ACTION OF 2 LOADS  $P$  PLACED AS SHOWN, FOR SLABS HAVING MAIN REINFORCEMENT TRANSVERSE TO THE DIRECTION OF TRAFFIC.

$\Delta M_x$ =the increase in moment  $M_{0x}$  caused by placing two wheel loads on the span in position for maximum moment.

$a$ =distance between loads.

For values of  $M_{0x}$  and of  $M_x$ , see figure 2. For values of  $\Sigma M_x$  and of  $M_{0x} + \Sigma M_x$ , when loading is limited to two trucks, see figure 2. For values of  $\Delta M_x$ , see figure 3.

**Slabs fully restrained.**—For fully restrained slabs, the moment for one wheel on the center line of the slab is  $M'_{0x} = M_{0x} - 0.0699 P$ ---Equation (104)  $M'_{0x}$ =maximum moment in foot-pounds per foot width, on the center line of a fully restrained slab, produced by a single load  $P$  on the center line of the slab.

Moment for two or more wheels on the center line of fully restrained slabs is considered next. Equation (104) gives the moment  $M'_{0x}$  produced by one load  $P$  on the center line of the slab. If a second load  $P_1$  is placed on the center line of slab at a distance  $y$  in feet from  $P$ , the maximum moment per foot width of slab at load  $P$  will be  $M'_{0x} + M'_x$ .

$$M'_x - M_x = \frac{PS}{2l} \sum_{1,3,5...}^n \frac{\cos \omega_n y \tanh \alpha_n}{\sinh 2\alpha_n + 2\alpha_n} [(1-\mu)\alpha_n \tanh \alpha_n - 2]$$

---Equation (102)

$M'_x$ =the increase in moment  $M'_{0x}$  caused by an additional load on the center line of the slab, at distance  $y$  from  $P$ . When more than two loads are placed on the center line of the slab, the maximum moment per foot width of slab is  $M'_{0x} + \Sigma M'_x$ .

For values of  $M'_{0x}$  and of  $M'_x$ , see figure 2. For values of  $\Sigma M'_x$  and of  $M'_{0x} + \Sigma M'_x$ , when load is limited to two trucks, see figure 2.

Moment per foot width of slab for two wheels placed in the direction of the span in position for maximum moment for fully restrained slabs is discussed next.

Westergaard shows formulas for finding the maximum moment per foot width of slab, when two loads are placed in the direction of the span in position for maximum moment. This is  $M_{0x} + \Delta M_x$  when the slab is freely supported. When the slab is fully restrained,  $M_{0x}$  becomes  $M'_{0x}$  but Westergaard does not show how

the term  $\Delta M_x$  is changed when the slab is fully restrained. It can be shown that the term  $\Delta M_x$  is small compared to  $M_{0x}$  for short spans. If no reduction is applied to the term  $\Delta M_x$  because of restraining the slab, the error will be small and on the safe side. So  $M'_{0x} + \Delta M_x$  will be considered as the maximum moment per foot width of slab, for two wheels placed in the direction of the span in position for maximum moment when the slab is fully restrained.

For values of  $\Delta M_x$  see figure 3.

*Slabs partially restrained.*—When slabs are continuous over supports, as shown in figures 4 and 5, they are neither freely supported nor totally fixed, but are partially restrained.

The Westergaard study does not advance formulas for partially restrained slabs; but since results for this condition fall between those for freely supported and totally fixed slabs, let slabs as in figure 4 and figure 5 be assumed to have 50 percent and 75 percent fixed end restraint, respectively. These assumptions are based upon the probable effect that continuity of the slab, yielding supports, and other influencing factors, may have on the degree of fixation at the supports. Then the moment for slabs as in figure 4 will be the average of

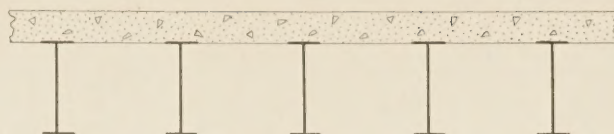

FIGURE 4.—CONTINUOUS SLAB ASSUMED TO HAVE 50 PERCENT FIXED END RESTRAINT.

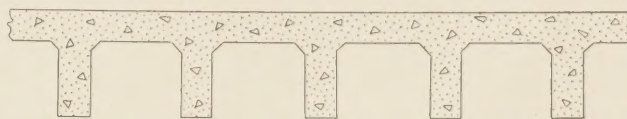

FIGURE 5.—CONTINUOUS SLAB ASSUMED TO HAVE 75 PERCENT FIXED END RESTRAINT.

moments for the simple span and for the totally fixed slab. The moment for slabs, as in figure 5, will be the moment for a simple span reduced by three-fourths the difference between the moments for a simple span and for a totally fixed slab.

Formulas for maximum moment for 50 and 75 percent fixed end restraint will be given in subsequent tables.

Part 2.—MODIFIED FORMULAS

The values obtained by the Westergaard formulas for 2-truck loading can be very closely approximated by the use of a factor  $E$  for the effective width over which the wheel load is distributed when only one wheel is involved, and by a factor  $H$  for the "equivalent effective width" when two or more wheels are involved. The width  $H$  is considered as the equivalent effective width for one wheel load to give the effect, in terms of maximum moment, of two or more wheels on the slab arranged for maximum bending.

The modified formulas have been developed for slabs with the two types of reinforcement, case I and case II.

Under cases I and II, modified formulas will be shown for slabs (1) freely supported, (2) fully restrained, (3) having 75 percent fixed end restraint, and (4) having 50 percent fixed end restraint.

Since the various modified formulas advanced in this study were developed by similar methods, only the method of development for slabs freely supported, case I, will be shown.

*Slabs freely supported, case I.*—The procedure in the development of the modified formulas for this case follows.

Figure 6 shows the moment values resulting from each of the four equal wheel loads,  $P_1, P_2, P_3,$  and  $P_4$  at their respective points of application, by curves  $M_{0x}$ , and at points  $y$  distance from the wheels by curves  $M_x$ . The area under the curve  $\Sigma M_x$ , the total bending moment produced by the four wheels, is equal to  $PS$ . The maximum moment produced by the four wheels is  $M_{0x} + \Sigma M_x$  and is under the wheel load having the greatest value of  $\Sigma M_x$ . The total moment area under curve  $\Sigma M_x$  can be represented by an equivalent rectangle with an ordinate  $= M_{0x} + \Sigma M_x$  (the maximum moment produced on the slab) and an abscissa  $H_T$  (the effective width for the four wheels). The area of the rectangle is  $(M_{0x} + \Sigma M_x) \times H_T = PS$  from

which  $H_T = \frac{PS}{(M_{0x} + \Sigma M_x)}$ . Substituting the values of  $M_{0x}$  and  $\Sigma M_x$  obtained from Westergaard's equations (66) and (74), the value of  $H_T$  is found to be approximately  $(0.66 S + 12.4)$  and  $(M_{0x} + \Sigma M_x) = \frac{PS}{0.66 S + 12.4}$ .

The total moment produced by one wheel is  $\frac{PS}{4}$  and the area of the equivalent rectangle for one wheel is  $(M_{0x} + \Sigma M_x) \times \frac{H_T}{4} = \frac{PS}{4}$ . The equivalent effective width for one wheel that will give the effect, in terms of maximum moment of the four wheels, is then  $H = \frac{H_T}{4} = \frac{0.66 S + 12.4}{4} = (0.165 S + 3.10)$  and  $M_{0x}$

$+ \Sigma M_x = \frac{PS}{4H} = \frac{PS}{4(0.165 S + 3.10)}$ . By substituting  $M$  for  $M_{0x} + \Sigma M_x$  the modified formula for freely supported slabs with main reinforcement parallel to the direction of traffic becomes:

$$M = \frac{PS}{4H} = \frac{PS}{0.66 S + 12.4} \text{-----Modified formula (1)}$$

In like manner formulas for the remaining conditions of end support and end restraint under case I may be developed, the formulas being as follows:

*Slabs fully restrained.*—

$$M = \frac{PS}{8H} = \frac{PS}{0.66 S + 24.8} \text{-----Modified formula (2)}$$

*Slabs with 50 percent end restraint (as assumed for condition shown by fig. 4).*—

$$M = \frac{PS}{5.5 H} = \frac{PS}{0.66 S + 17.05} \text{---Modified formula (3)}$$

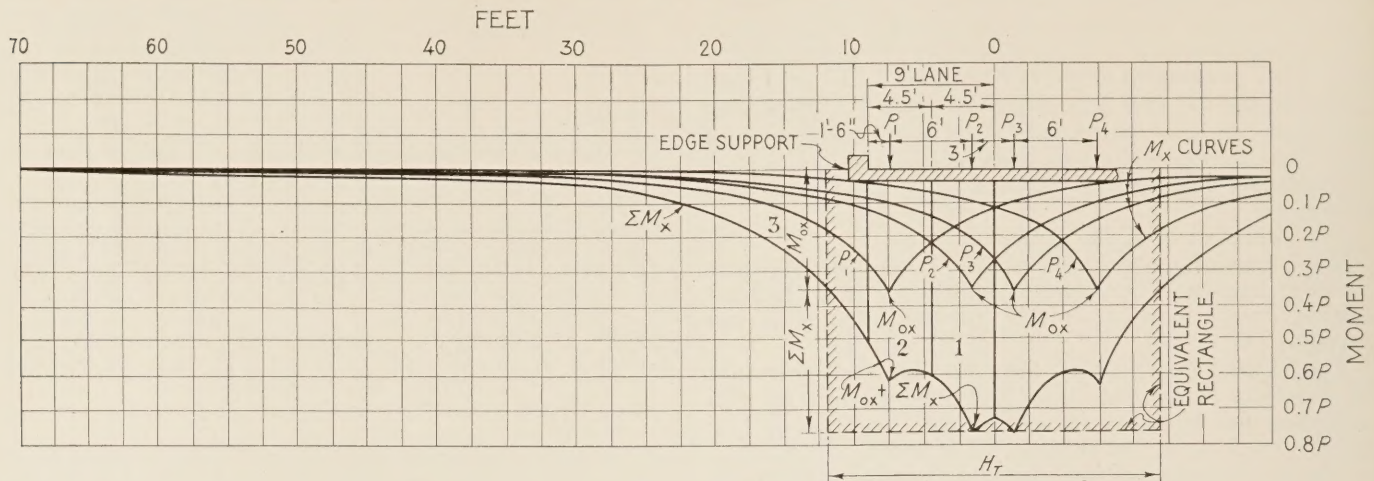

The  $M_x$  curves show the variation in moment in a slab of unlimited width and 20-foot span for equal loads  $P_1, P_2, P_3,$  and  $P_4$  and the summation of the  $M_x$  curves is shown by curve  $\Sigma M_x$ . When the slab has a limited width as shown by the superimposed sketch of slab, the inner 4.5 feet of the lane can be assumed to carry the moment represented by area 1; the outer 4.5 feet of lane is assumed to carry the moment represented by area 2, and the edge support is assumed to carry the moment represented by area 3.

Moments represented by areas 1, 2, and 3 for 5-, 10-, 15-, 20-, and 25-foot spans

Span (feet)	Total moment distributed to various sections of slab			
	Inner 4.5 feet	Outer 4.5 feet	Edge support	9-foot lane plus edge support
5.....	1. 2165 P	0. 9765 P	0. 3070 P	2. 5 P
10.....	2. 1500 P	1. 7150 P	1. 1350 P	5. 0 P
15.....	2. 8005 P	2. 2995 P	2. 4000 P	7. 5 P
20.....	3. 2760 P	2. 7600 P	3. 9640 P	10. 0 P
25.....	3. 6500 P	3. 1275 P	5. 7225 P	12. 5 P

FIGURE 6.—DISTRIBUTION OF MOMENTS ALONG THE  $y$ -AXIS, SHOWING EQUIVALENT EFFECTIVE WIDTH OF DISTRIBUTION  $H_T$ ; FOR A SLAB HAVING FREELY SUPPORTED ENDS, A 20-FOOT SPAN, 2 TRUCK LOADING, AND HAVING MAIN REINFORCEMENT PARALLEL TO THE DIRECTION OF TRAFFIC.

Slabs with 75 percent end restraint (as assumed for condition shown by fig. 5).—

$$M = \frac{PS}{6.5 H} = \frac{PS}{0.66 S + 20.15} \text{---Modified formula (4)}$$

Table 1 gives a summary of the modified and Westergaard formulas for maximum moment per foot width of slab, when reinforcement is parallel to direction of traffic (case I).

For a comparison of the moment values by the modified and Westergaard formulas, see figure 7.

TABLE 1.—Westergaard and modified formulas for maximum moment

Condition of slab at support	Westergaard formulas for moment values	Modified formulas giving equivalent moment values, $M$
Freely supported.....	$M_{0x} + \Sigma M_x$	$\frac{PS}{0.66 S + 12.4}$
50 percent end restraint.....	$\frac{M_{0x} + \Sigma M_x + M'_{0x} + \Sigma M'_x}{2}$	$\frac{PS}{0.66 S + 17.05}$
75 percent end restraint.....	$\frac{M_{0x} + \Sigma M_x + 3M'_{0x} + 3\Sigma M'_x}{4}$	$\frac{PS}{0.66 S + 20.15}$
Fully restrained.....	$M'_{0x} + \Sigma M'_x$	$\frac{PS}{0.66 S + 24.8}$

Edge support requirements.—For a wheel load placed on the center line of a slab, Westergaard's equation (74) shows the moment  $M_x$  produced on the center line of the slab at  $y$  distance from the load. Figure 8 shows that  $M_x$  is a maximum when the  $y$  distance is zero and that  $M_x$  is a minimum when the  $y$  distance is 3.0  $S$ . Therefore, in slabs of unlimited width, as the span increases the width of slab in which moment is produced increases.

Figure 6 shows the moment  $M_x$ , at any point on the center line of a freely supported slab of unlimited width and 20-foot span, produced by each wheel for two trucks spaced 9 feet between centers. The curve  $\Sigma M_x$  shows the moment at any point in a slab of unlimited width produced by the four rear wheels, with a sketch of a slab of limited width superimposed. The total moment produced by the four wheels is  $\frac{4 PS}{4}$  or  $PS$ .

In a slab of limited width, when the loads are placed so that the outside load is 1 foot 6 inches from the face of the curb, a section of the slab and curb 9 feet wide is assumed to carry one half of the total moment produced by the four wheels, or  $\frac{PS}{2}$ . The moment  $\frac{PS}{2}$  can be considered as distributed to the slab and edge support as shown in figure 6.



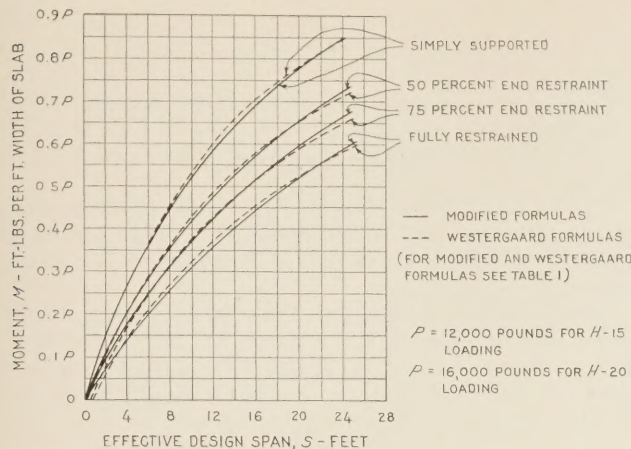

FIGURE 7.—COMPARISON OF LIVE-LOAD BENDING MOMENTS PER FOOT WIDTH OF SLAB BY MODIFIED FORMULAS AND WESTERGAARD FORMULAS, FOR SLABS HAVING MAIN REINFORCEMENT PARALLEL TO THE DIRECTION OF TRAFFIC.

Let  $M_E$  be the moment, under the conditions indicated in figure 6, for which the edge support must provide. Then the modified formula for edge support requirement will be  $M_E = 0.01 PS^2$  for freely supported slabs.

The edge support requirement for slabs partially restrained and fully restrained may be provided for by using  $0.8 M_E$  or  $0.008 PS^2$  for 50 percent end restraint;  $0.7 M_E$  or  $0.007 PS^2$  for 75 percent end restraint; and  $0.5 M_E$  or  $0.005 PS^2$  for slabs fully restrained. The factors 1.0, 0.8, 0.7, and 0.5 represent approximately the variation in slab moments as computed by the modified formulas for the various conditions of support.

**Reinforcement in direction of  $y$ -axis.**—The previous discussion has dealt with moments in the direction of the span for which the main reinforcement is provided, referred to by Westergaard as moments in the direction of the  $x$ -axis. In addition to the moments in the direction of the slab span, there are moments produced in slabs normal to the span, referred to by Westergaard as moments in the direction of the  $y$ -axis, and for which reinforcement must be provided.

For a single load on the center line of a freely supported slab, the moment in the direction of the  $y$ -axis is given by Westergaard's equation (62) as

$$M_{0y} = M_{0x} - 0.0676 P.$$

For two wheels on the center line of a freely supported slab, a distance  $y$  apart, the moment in the direction of the  $y$ -axis is  $M_{0y} + M_y$ . Values of  $M_y$  can be determined from Westergaard's equation (74).

For 2-truck loading with four rear wheels on the center line of the slab, when trucks are spaced 9 feet between centers, the moment in the direction of the  $y$ -axis is  $M_{0y} + \Sigma M_y$ , where  $\Sigma M_y$  is the summation of values of  $M_y$  for  $y=3$  feet,  $y=6$  feet, and  $y=9$  feet. The values of  $M_y$  may be obtained from figure 8.

Figure 9 shows the maximum live-load moments plus impact moments in the direction of the  $y$ -axis, curves 1 and 2; the total moments for which main reinforcement must be provided are shown by curves 3 and 4; and the ratios of maximum moments in the direction of the  $y$ -axis to the total moments for which main reinforcement must be provided, expressed as percentages, are shown by curves 5 and 6.

The moments along the  $y$ -axis are small at points near the supports, and the maximum occurs at the

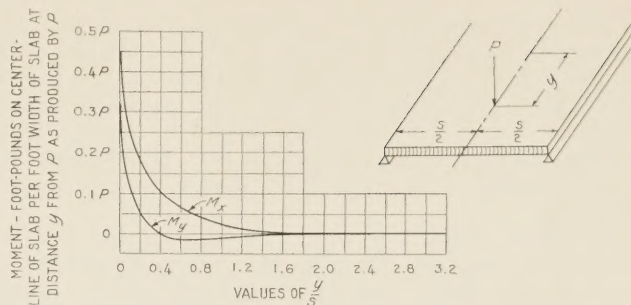

FIGURE 8.—BENDING MOMENTS ON CENTER LINE OF SIMPLY SUPPORTED SLAB AT DISTANCE  $y$  FROM  $P$  AS PRODUCED BY  $P$ , FOR SLABS HAVING MAIN REINFORCEMENT PARALLEL TO THE DIRECTION OF TRAFFIC.

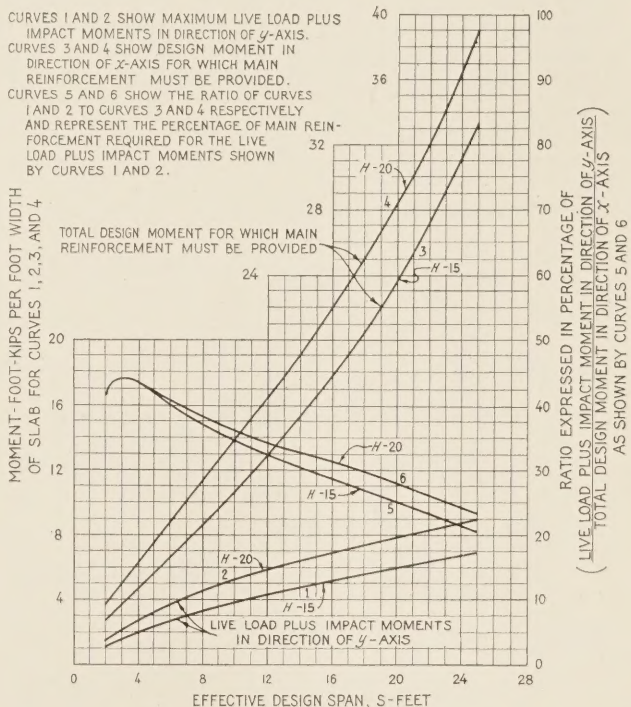

FIGURE 9.—PERCENTAGE OF MAIN REINFORCEMENT REQUIRED IN BOTTOM OF SLAB IN DIRECTION OF  $y$ -AXIS, FOR SLABS HAVING MAIN REINFORCEMENT PARALLEL TO THE DIRECTION OF TRAFFIC.

center. Since the variations in percentages shown in figure 9 are not large, it is recommended that, for slabs with main reinforcement parallel to the direction of traffic, the bottom of the slab, in the direction transverse to traffic, be reinforced with the percentages of main reinforcement shown in table 2, where practicable.

TABLE 2.—Percentages of main reinforcement recommended for the bottom of the slab, in the direction transverse to traffic

Span length	In middle half of span	In outer quarters of span
	Percent	Percent
Under 10 feet.....	45	30
10 to 20 feet.....	35	25
Over 20 feet.....	25	15

Bridge floor slabs with main reinforcement transverse to the direction of traffic usually consist of several spans continuous on stringers or built monolithic with the supporting girders. For slab spans so arranged, the

maximum moment per foot width of slab in exterior spans will be produced by one rear wheel on the center line of the span for spans up to 10 feet. On interior spans, the maximum moment per foot width of slab will be produced by one rear wheel on the center line of the span for spans up to 5.14 feet, and by two rear wheels placed 3 feet apart for spans from 5.14 to 10 feet.

In order to simplify the moment computations and also to provide for the possibility of loads spaced less than 3 feet apart, the modified formulas for interior spans loaded with two wheels are developed for slab spans from 4 feet to 10 feet.

The modified formulas for computing the live-load bending moments per foot width of slab for slabs with main reinforcement transverse to the direction of traffic are developed in a manner similar to that used for slabs freely supported of case I, and are as follows:

*Slabs freely supported, case II.*—Spans less than 4 feet.

$$M = \frac{PS}{4E} = \frac{P\sqrt{S}}{9.64} \text{-----Modified formula (5)}$$

Exterior spans 4 to 10 feet,

$$M = \frac{PS}{4E} = \frac{PS}{2.32S+10.0} \text{-----Modified formula (6)}$$

Interior spans 4 to 10 feet,

$$M = \frac{PS}{4H} = \frac{PS}{1.32S+14.0} \text{-----Modified formula (7)}$$

*Slabs fully restrained.*—Spans less than 4 feet,

$$M = \frac{P\sqrt{S}}{9.64} - 0.07P \text{-----Modified formula (8)}$$

Exterior spans 4 to 10 feet,

$$M = \frac{PS}{2.32S+10.0} - 0.07P \text{-----Modified formula (9)}$$

Interior spans 4 to 10 feet,

$$M = \frac{PS}{1.32S+14.0} - 0.07P \text{-----Modified formula (10)}$$

*Slabs with 50 percent end restraint (as assumed for condition shown by figure 4).*—Spans less than 4 feet,

$$M = \frac{P\sqrt{S}}{9.64} - 0.035P \text{-----Modified formula (11)}$$

Exterior spans 4 to 10 feet,

$$M = \frac{PS}{2.32S+10.0} - 0.035P \text{-----Modified formula (12)}$$

Interior spans 4 to 10 feet,

$$M = \frac{PS}{1.32S+14.0} - 0.035P \text{-----Modified formula (13)}$$

*Slabs with 75 percent end restraint (as assumed for condition shown by figure 5).*—Spans less than 4 feet,

$$M = \frac{P\sqrt{S}}{9.64} - 0.0525P \text{-----Modified formula (14)}$$

Exterior spans 4 to 10 feet,

$$M = \frac{PS}{2.32S+10.0} - 0.0525P \text{-----Modified formula (15)}$$

Interior spans 4 to 10 feet,

$$M = \frac{PS}{1.32S+14.0} - 0.0525P \text{-----Modified formula (16)}$$

Table 3 gives a summary of the Westergaard formulas for interior and exterior spans. Table 4 gives a summary of the modified formulas for interior and exterior spans.

Figure 10 shows a comparison of the moment values by the modified and Westergaard formulas for interior spans, and figure 11 shows a comparison for exterior spans.

*Requirements at unsupported edges.*—For slabs with main reinforcement transverse to the direction of traffic, where the continuity of the slab is broken, the edges of the slab require support by diaphragms or other suitable means.

TABLE 3.—Summary of Westergaard formulas for interior and exterior spans

Condition of slab at support	Span	Exterior spans	Interior spans
	<i>Feet</i>		
Freely supported.....	2 to 10.....	$M_{0x}$	$M_{0x}$
	2 to 5.14.....		$M_{0x} + \Delta M_x$
	5.14 to 10.....		
Fully restrained.....	2 to 10.....	$M'_{0x}$	$M'_{0x}$
	2 to 5.14.....		$M'_{0x} + \Delta M_x$
	5.14 to 10.....		
50 percent end restraint...	2 to 10.....	$\frac{M_{0x} + M'_{0x}}{2}$	
	2 to 5.14.....		$\frac{M_{0x} + M'_{0x}}{2}$
	5.14 to 10.....		$\frac{M_{0x} + M'_{0x} + 2\Delta M_x}{2}$
75 percent end restraint...	2 to 10.....	$\frac{M_{0x} + 3M'_{0x}}{4}$	
	2 to 5.14.....		$\frac{M_{0x} + 3M'_{0x}}{4}$
	5.14 to 10.....		$\frac{M_{0x} + 3M'_{0x} + 4\Delta M_x}{4}$

TABLE 4.—Summary of modified formulas for interior and exterior spans

Condition of slab at support	Span	Exterior spans	Interior spans
	<i>Feet</i>		
Freely supported.....	0 to 4.....	$M = \frac{P\sqrt{S}}{9.64}$	$M = \frac{P\sqrt{S}}{9.64}$
	4 to 10.....	$M = \frac{PS}{2.32S+10}$	$M = \frac{PS}{1.32S+14}$
Fully restrained.....	0 to 4.....	$M = \frac{P\sqrt{S}}{9.64} - 0.07P$	$M = \frac{P\sqrt{S}}{9.64} - 0.07P$
	4 to 10.....	$M = \frac{PS}{2.32S+10} - 0.07P$	$M = \frac{PS}{1.32S+14} - 0.07P$
50 percent end restraint.	0 to 4.....	$M = \frac{P\sqrt{S}}{9.64} - 0.035P$	$M = \frac{P\sqrt{S}}{9.64} - 0.035P$
	4 to 10.....	$M = \frac{PS}{2.32S+10} - 0.035P$	$M = \frac{PS}{1.32S+14} - 0.035P$
75 percent end restraint	0 to 4.....	$M = \frac{P\sqrt{S}}{9.64} - 0.0525P$	$M = \frac{P\sqrt{S}}{9.64} - 0.0525P$
	4 to 10.....	$M = \frac{PS}{2.32S+10} - 0.0525P$	$M = \frac{PS}{1.32S+14} - 0.0525P$

*Reinforcement in direction of y-axis.*—Since the slabs for case II are limited to spans of 10 feet and less, the maximum moment  $M_{0y}$  in the direction of the  $y$ -axis will be the moment caused by one wheel load on the center line of the slab for exterior spans.

$$M_{0y} = M_{0x} - 0.0676P \text{---(Equation 62)}$$

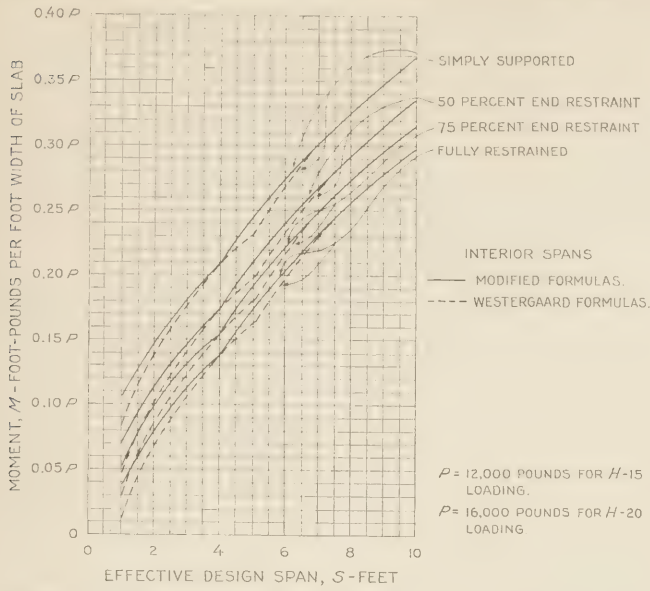

FIGURE 10.—COMPARISON OF LIVE-LOAD BENDING MOMENTS IN INTERIOR SPANS PER FOOT WIDTH OF SLAB BY MODIFIED AND WESTERGAARD FORMULAS, FOR SLABS HAVING MAIN REINFORCEMENT TRANSVERSE TO THE DIRECTION OF TRAFFIC.

The maximum moment  $M_{0y}$  in the direction of the  $y$ -axis for interior spans will be produced by one load on the center line of slab for slabs with spans less than 5.14 feet. For slabs with spans from 5.14 feet to 10 feet, the maximum moment in the direction of the  $y$ -axis will be produced by two wheels 3 feet apart placed in the direction of the span. For this position of loads, the moment in the direction of  $y$  will be  $M_{0y} + \Delta M_y$ . Values of  $\Delta M_y$  may be obtained from figure 3.

Figure 12 shows the maximum live-load moments plus impact moments in the direction of the  $y$ -axis, curves 1 and 2; the total moments in the direction of the  $x$ -axis for which the main reinforcement must be provided are shown by curves 3 and 4; and the ratio of maximum moments in the direction of  $y$  to total moments in the direction of  $x$  is shown by curve 5. Since curve 5 shows the moment in the direction of  $y$  expressed in percentage of the moment in the direction of  $x$ , the same curves could be used to determine the percentage of main steel to be used in the direction of  $y$ .

The maximum percentage of main reinforcement required in the direction of the  $y$ -axis is shown by curve 5, figure 12, to vary from 50 to 69 percent. For practical application it is recommended that the following percentages of main reinforcement be provided per foot width of slab in the direction of the  $y$ -axis.

Element of slab:	Percentage of main reinforcement per foot width of slab
Middle half of slab span.....	65
Outer quarters of slab span.....	45

The reinforcement required in the direction of the  $y$ -axis is to be used in the bottom of the slab and is in addition to any temperature reinforcement used in the top of the slab.

*Provision for negative moments at supports.*—The modified formulas are for moments at or near the

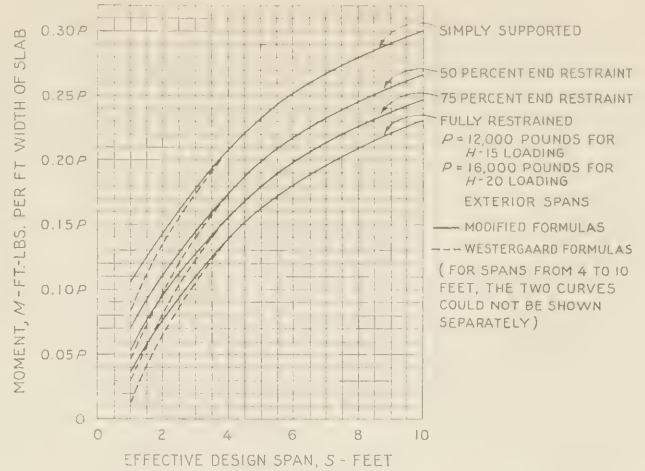

FIGURE 11.—COMPARISON OF LIVE-LOAD BENDING MOMENTS IN EXTERIOR SPANS PER FOOT WIDTH OF SLAB BY MODIFIED AND WESTERGAARD FORMULAS, FOR SLABS HAVING MAIN REINFORCEMENT TRANSVERSE TO THE DIRECTION OF TRAFFIC.

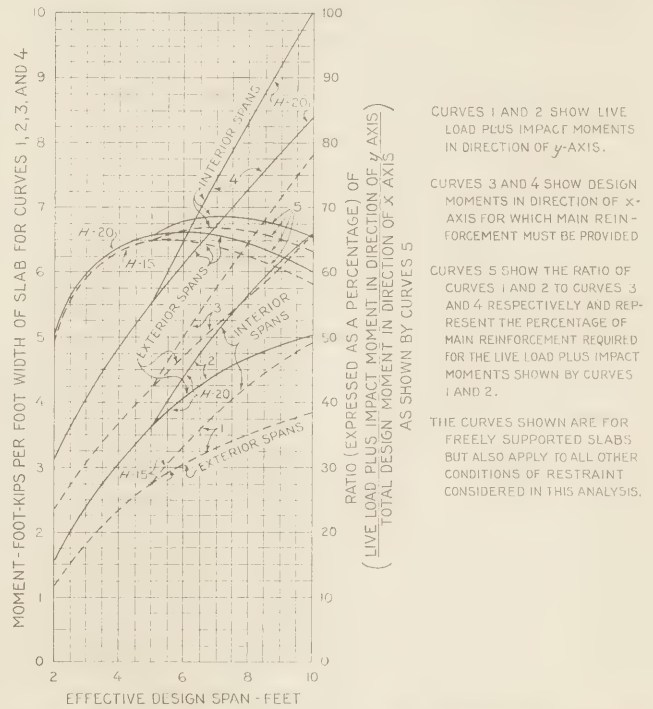

FIGURE 12.—PERCENTAGE OF MAIN REINFORCEMENT REQUIRED IN BOTTOM OF SLABS IN DIRECTION OF THE  $y$ -AXIS, FOR SLABS HAVING MAIN REINFORCEMENT TRANSVERSE TO THE DIRECTION OF TRAFFIC. (Also see tabulation on p. 155.)

center line of the span. The bridge floor slabs, except those freely supported, are designed to have practically the same moment of resistance (negative) over the supports as (positive) at the middle of the span.

*Cantilever slabs.*—The modified formulas developed in this analysis apply only to slabs adequately supported at the sides and ends and do not apply to cantilevered portions of slabs or where cantilevered portions affect the slab.

Part 3.—DESIGN OF REINFORCED CONCRETE BRIDGE FLOOR SLABS BY MODIFIED FORMULAS

Case I.—Modified formulas will be applied in the design of reinforced concrete bridge floor slabs with main reinforcement parallel to the direction of traffic.

The 1935 specifications of the American Association of State Highway Officials will be used, modified as follows:

Live load moments are computed according to modified formulas as shown in table 5.

The outer edges of the slab shall be supported by a beam or extra slab width capable of resisting live-load edge support moment  $M_E$ , live-load impact and dead-load moment.

Unit stresses:  $f'_c=3,000$  pounds per square inch;  $f_s=18,000$  pounds per square inch;  $f_c=800$  pounds per square inch;  $n=12$ .

Live load: *H-15* and *H-20* truck train loading, on two adjacent lanes for all roadway widths.

Symbols used are defined as follows:

- $S$ =Effective design span in feet.
- $W$ =Dead load per square foot of slab.
- $P$ =Wheel load=12,000 pounds for *H-15* and 16,000 pounds for *H-20* loading.

$$I = \text{Impact factor} = \frac{50}{125 + S}$$

- $M$ =Maximum live load moment.
- $M(1.0+I)$ =Live load+impact moment.
- $M_t$ =Design moment=Dead load moment+ $M(1.0+I)$ .

$M_E$ =Live-load moment in foot-pounds distributed to edge support.

$M_E(1.0+I)$ =Live load+impact moment in foot-pounds distributed to edge support.

All moments except for  $M_E$  (edge support) are in foot-pounds per foot width of slab.

For values of live-load moments in foot-pounds per foot width of slab by above formulas, see tables 6 and 8.

For values of live-load moments distributed to edge support, see tables 7 and 9.

Tables 10 to 17 show design moments, dimensions and reinforcement of slabs for case I.

TABLE 6.—Live load moments in foot-pounds per foot width of slab

Controlling conditions:  
*H-15* loading.  
 $P=12,000$  pounds.  
 Case I.—parallel reinforcement.  
 Modified formulas.  
 Freely supported.  
 Slabs continuous.  
 Slabs monolithic.  
 Fully restrained.

Slab span S, feet	Condition at support		Freely supported		Slabs continuous, 50 percent end restraint		Slabs monolithic, 75 percent end restraint		Fully restrained	
	$I = \frac{50}{125+S}$	$M = \frac{PS}{0.66S+12.4}$	$M$	$M \times (1.0+I)$	$M = \frac{PS}{0.66S+17.05}$	$M \times (1.0+I)$	$M = \frac{PS}{0.66S+20.15}$	$M \times (1.0+I)$	$M = \frac{PS}{0.66S+24.8}$	$M \times (1.0+I)$
2.0	0.394	1,750	2,440	1,310	1,830	1,120	1,560	920	1,280	
2.5	.392	2,140	2,980	1,600	2,230	1,380	1,920	1,130	1,570	
3.0	.391	2,510	3,480	1,890	2,630	1,630	2,270	1,340	1,865	
3.5	.390	2,850	3,960	2,170	3,020	1,870	2,600	1,550	2,150	
4.0	.388	3,190	4,430	2,440	3,390	2,100	2,920	1,750	2,430	
4.5	.386	3,520	4,880	2,700	3,740	2,330	3,230	1,950	2,700	
5.0	.385	3,830	5,300	2,950	4,090	2,560	3,540	2,140	2,965	
5.5	.383	4,110	5,680	3,190	4,410	2,770	3,830	2,330	3,220	
6.0	.382	4,400	6,080	3,430	4,740	2,990	4,130	2,510	3,470	
6.5	.380	4,680	6,460	3,650	5,040	3,190	4,400	2,680	3,700	
7.0	.379	4,940	6,810	3,870	5,340	3,390	4,670	2,850	3,930	
7.5	.377	5,180	7,140	4,090	5,630	3,590	4,950	3,030	4,170	
8.0	.376	5,430	7,460	4,300	5,920	3,780	5,200	3,200	4,400	
8.5	.375	5,670	7,800	4,500	6,190	3,960	5,450	3,360	4,620	
9.0	.373	5,890	8,085	4,700	6,450	4,130	5,670	3,520	4,830	
9.5	.372	6,100	8,370	4,890	6,710	4,310	5,920	3,670	5,040	
10.0	.370	6,310	8,645	5,070	6,950	4,480	6,140	3,820	5,240	
11.0	.368	6,700	9,165	5,420	7,420	4,810	6,580	4,130	5,650	
12.0	.365	7,090	9,680	5,770	7,870	5,130	7,000	4,400	6,010	
13.0	.362	7,440	10,140	6,080	8,290	5,410	7,370	4,660	6,350	
14.0	.360	7,760	10,550	6,390	8,690	5,700	7,750	4,940	6,720	
15.0	.357	8,080	10,960	6,670	9,060	5,980	8,100	5,180	7,030	
16.0	.355	8,360	11,330	6,950	9,420	6,240	8,460	5,430	7,360	
17.0	.352	8,630	11,670	7,210	9,760	6,500	8,780	5,670	7,660	
18.0	.350	8,890	12,000	7,460	10,080	6,720	9,070	5,880	7,940	
19.0	.347	9,150	12,330	7,700	10,380	6,950	9,370	6,110	8,230	
20.0	.345	9,370	12,600	7,930	10,670	7,180	9,640	6,320	8,500	
21.0	.342	9,600	12,880	8,140	10,940	7,390	9,900	6,530	8,760	
22.0	.340	9,810	13,150	8,350	11,190	7,600	10,180	6,720	9,000	
23.0	.338	9,990	13,370	8,560	11,460	7,790	10,430	6,900	9,240	
24.0	.336	10,200	13,630	8,740	11,700	7,980	10,660	7,060	9,440	
25.0	.333	10,380	13,810	8,930	11,920	8,160	10,880	7,270	9,700	

TABLE 5.—Summary of modified formulas for case I

Type of slab	Requirements regarding slab and supports	Percentage of end restraint assumed	Live load moments per foot width of slab, $M$	Live load moment distributed to edge support, $M_E$	Dead load moment
Freely supported	Single spans	0	$\frac{PS}{0.66S+12.4}$	$0.01 PS^2$	$\frac{WS^2}{8}$
Slabs continuous	Reinforced concrete slabs bearing on 3 or more supports and continuous over 2 or more panels	50	$\frac{PS}{0.66S+17.05}$	$0.008 PS^2$	$\frac{WS^2}{10}$
Slabs monolithic	Reinforced concrete slabs built monolithic with 3 or more supports and continuous over 2 or more panels	75	$\frac{PS}{0.66S+20.15}$	$0.007 PS^2$	$\frac{WS^2}{10}$
Fully restrained	Exceptional cases only	100	$\frac{PS}{0.66S+24.8}$	$0.005 PS^2$	$\frac{WS^2}{12}$

TABLE 7.—Live load moments in foot-pounds distributed to edge supports

Controlling conditions:  
 H-15 loading.  
 P=12,000 pounds.  
 Case I.—parallel reinforcement.  
 Modified formulas.  
 Freely supported.  
 Slabs continuous.  
 Slabs monolithic.  
 Fully restrained.

Condition at support		Freely supported		Slabs continuous, 50 percent end restraint		Slabs monolithic, 75 percent end restraint		Fully restrained	
Slab span S, feet	$I = \frac{50}{125+S}$	$M_E = 0.01 PS^2$		$M_E = 0.008 PS^2$		$M_E = 0.007 PS^2$		$M_E = 0.005 PS^2$	
		S	I	M <sub>E</sub>	M <sub>E</sub> × (1.0+I)	M <sub>E</sub>	M <sub>E</sub> × (1.0+I)	M <sub>E</sub>	M <sub>E</sub> × (1.0+I)
2.0	0.394	480	670	385	535	335	470	240	335
2.5	.392	750	1,045	600	835	525	730	375	525
3.0	.391	1,080	1,500	865	1,200	750	1,050	540	750
3.5	.390	1,470	2,040	1,175	1,640	1,030	1,425	735	1,020
4.0	.388	1,920	2,665	1,540	2,125	1,345	1,865	960	1,330
4.5	.386	2,430	3,370	1,945	2,700	1,700	2,365	1,215	1,690
5.0	.385	3,000	4,160	2,400	3,325	2,100	2,910	1,500	2,080
5.5	.383	3,630	5,030	2,900	4,075	2,540	3,515	1,815	2,510
6.0	.382	4,320	5,975	3,465	4,775	3,025	4,185	2,160	2,990
6.5	.380	5,070	7,000	4,065	5,600	3,550	4,900	2,535	3,500
7.0	.379	5,880	8,110	4,700	6,475	4,125	5,675	2,940	4,050
7.5	.377	6,750	9,300	5,400	7,440	4,725	6,510	3,375	4,650
8.0	.376	7,680	10,560	6,140	8,450	5,375	7,400	3,840	5,280
8.5	.375	8,670	11,920	6,940	9,550	6,075	8,350	4,335	5,960
9.0	.373	9,720	13,330	7,770	10,680	6,800	9,350	4,860	6,660
9.5	.372	10,830	14,850	8,670	11,880	7,570	10,400	5,415	7,430
10.0	.370	12,000	16,440	9,600	13,150	8,400	11,500	6,000	8,220
11.0	.368	14,520	19,880	11,620	15,890	10,170	13,920	7,260	9,940
12.0	.365	17,280	23,620	13,820	18,880	12,100	16,530	8,640	11,810
13.0	.362	20,280	27,630	16,250	22,100	14,180	19,350	10,140	13,820
14.0	.360	23,520	32,000	18,820	25,600	16,460	22,370	11,760	16,000
15.0	.357	27,000	36,640	21,620	29,280	18,880	25,620	13,500	18,320
16.0	.355	30,720	41,640	24,570	33,300	21,500	29,100	15,360	20,820
17.0	.352	34,680	46,890	27,750	37,500	24,320	32,850	17,340	23,450
18.0	.350	38,880	52,500	31,120	42,000	27,250	36,750	19,440	26,250
19.0	.347	43,320	58,400	34,660	46,700	30,360	40,850	21,660	29,200
20.0	.345	48,000	64,600	38,370	51,650	33,600	45,200	24,000	32,300
21.0	.342	52,920	71,000	42,380	56,760	37,060	49,750	26,460	35,500
22.0	.340	58,080	77,800	46,480	62,280	40,700	54,500	29,040	38,900
23.0	.338	63,480	85,000	50,750	68,000	44,450	59,500	31,740	42,500
24.0	.336	69,120	92,400	55,350	73,880	48,360	64,700	34,560	46,200
25.0	.333	75,000	100,000	60,000	80,000	52,500	70,000	37,500	50,000

TABLE 8.—Live load moments in foot-pounds per foot width of slab—Continued

Condition at support		Freely supported		Slabs continuous, 50 percent end restraint		Slabs monolithic, 75 percent end restraint		Fully restrained	
Slab span S, feet	$I = \frac{50}{125+S}$	$M = \frac{PS}{0.66S+12.4}$		$M = \frac{PS}{0.66S+17.05}$		$M = \frac{PS}{0.66S+20.15}$		$M = \frac{PS}{0.66S+21.8}$	
		S	I	M	M × (1.0+I)	M	M × (1.0+I)	M	M × (1.0+I)
7.5	0.377	6,910	9,520	5,450	7,510	4,790	6,600	4,040	5,560
8.0	.376	7,240	9,940	5,730	7,900	5,040	6,930	4,260	5,860
8.5	.375	7,560	10,400	6,000	8,250	5,280	7,270	4,470	6,160
9.0	.373	7,840	10,770	6,270	8,600	5,510	7,560	4,690	6,440
9.5	.372	8,140	11,150	6,520	8,940	5,750	7,890	4,900	6,720
10.0	.370	8,410	11,520	6,760	9,260	5,970	8,180	5,100	6,980
11.0	.368	8,940	12,210	7,220	9,900	6,410	8,770	5,500	7,540
12.0	.365	9,450	12,900	7,690	10,490	6,840	9,330	5,870	8,020
13.0	.362	9,920	13,520	8,100	11,050	7,210	9,830	6,230	8,460
14.0	.360	10,350	14,060	8,520	11,580	7,600	10,330	6,590	8,960
15.0	.357	10,750	14,610	8,890	12,080	7,970	10,800	6,910	9,370
16.0	.355	11,150	15,100	9,260	12,550	8,320	11,270	7,240	9,810
17.0	.352	11,510	15,550	9,610	13,000	8,670	11,700	7,560	10,210
18.0	.350	11,850	16,000	9,950	13,440	9,060	12,090	7,850	10,590
19.0	.347	12,200	16,440	10,270	13,840	9,260	12,490	8,140	10,960
20.0	.345	12,490	16,800	10,570	14,230	9,570	12,850	8,450	11,330
21.0	.342	12,800	17,180	10,850	14,580	9,860	13,200	8,700	11,680
22.0	.340	13,080	17,540	11,130	14,910	10,130	13,570	8,960	12,000
23.0	.338	13,330	17,830	11,410	15,280	10,380	13,900	9,200	12,310
24.0	.336	13,600	18,170	11,650	15,600	10,640	14,210	9,410	12,580
25.0	.333	13,830	18,450	11,910	15,900	10,880	14,500	9,700	12,930

TABLE 9.—Live load moments in foot-pounds distributed to edge supports

Controlling conditions:  
 H-20 loading.  
 P=16,000 pounds.  
 Case I.—parallel reinforcement.  
 Modified formulas.  
 Freely supported.  
 Slabs continuous.  
 Slabs monolithic.  
 Fully restrained.

Condition at support		Freely supported		Slabs continuous, 50 percent end restraint		Slabs monolithic, 75 percent end restraint		Fully restrained	
Slab span S, feet	$I = \frac{50}{125+S}$	$M_E = 0.01 PS^2$		$M_E = 0.008 PS^2$		$M_E = 0.007 PS^2$		$M_E = 0.005 PS^2$	
		S	I	M <sub>E</sub>	M <sub>E</sub> × (1.0+I)	M <sub>E</sub>	M <sub>E</sub> × (1.0+I)	M <sub>E</sub>	M <sub>E</sub> × (1.0+I)
2.0	0.394	640	890	510	710	490	625	320	418
2.5	.392	1,000	1,390	800	1,115	700	975	450	695
3.0	.391	1,440	2,000	1,150	1,600	1,005	1,400	720	1,000
3.5	.390	1,960	2,730	1,560	2,180	1,370	1,995	980	1,365
4.0	.388	2,560	3,565	2,050	2,840	1,795	2,490	1,280	1,775
4.5	.386	3,240	4,500	2,585	3,600	2,265	3,150	1,620	2,250
5.0	.385	4,000	5,540	3,200	4,425	2,800	3,875	2,000	2,770
5.5	.383	4,840	6,700	3,875	5,365	3,390	4,690	2,420	3,350
6.0	.382	5,760	7,970	4,610	6,380	4,040	5,585	2,880	3,900
6.5	.380	6,760	9,340	5,410	7,480	4,740	6,540	3,350	4,670
7.0	.379	7,820	10,800	6,250	8,640	5,480	7,560	3,910	5,400
7.5	.377	9,000	12,400	7,200	9,950	6,300	8,670	4,500	6,200
8.0	.376	10,240	14,080	8,200	11,260	7,175	9,850	5,120	7,040
8.5	.375	11,580	15,900	9,250	12,720	8,100	11,130	5,790	7,950
9.0	.373	12,960	17,800	10,380	14,250	9,070	12,460	6,480	8,900
9.5	.372	14,440	19,800	11,550	15,850	10,110	13,880	7,220	9,900
10.0	.370	16,000	21,910	12,820	17,530	11,200	15,330	7,990	10,960
11.0	.368	17,800	24,160	14,200	19,280	12,350	16,820	8,800	12,080
12.0	.365	19,720	26,560	15,500	21,180	13,560	18,380	9,690	13,250
13.0	.362	21,760	29,100	16,840	23,150	14,820	19,980	10,620	14,480
14.0	.360	23,920	31,780	18,220	25,200	16,140	21,620	11,580	15,760
15.0	.357	26,200	34,600	19,640	27,320	17,500	23,300	12,580	17,080
16.0	.355	28,600	37,560	21,100	29,500	18,900	25,020	13,600	18,440
17.0	.352	31,120	40,680	22,600	31,840	20,340	26,780	14,660	19,840
18.0	.350	33,760	43,960	24,140	34,340	21,800	28,580	15,760	21,280
19.0	.347	36,520	47,400	25,720	36,980	23,280	30,420	16,880	22,760
20.0	.345	39,400	51,000	27,340	39,760	24,780	32,300	18,020	24,280
21.0	.342	42,400	54,760	29,000	42,680	26,300	34,220	19,180	25,840
22.0	.340	45,520	58,680	30,700	45,740	27,840	36,180	20,360	27,440
23.0	.338	48,760	62,760	32,440	48,940	29,400	38,180	21,560	29,080
24.0	.336	52,120	67,000	34,220	52,280	30,980	40,220	22,780	30,760
25.0	.333	55,600	71,500	36,040	55,860	32,580	42,300	24,020	32,480

TABLE 8.—Live load moments in foot-pounds per foot width of slab

Controlling conditions:  
 H-20 loading.  
 P=16,000 pounds.  
 Case I.—parallel reinforcement.  
 Modified formulas.  
 Freely supported.  
 Slabs continuous.  
 Slabs monolithic.  
 Fully restrained.

Condition at support		Freely supported		Slabs continuous, 50 percent end restraint		Slabs monolithic, 75 percent end restraint		Fully restrained	
Slab span S, feet	$I = \frac{50}{125+S}$	$M = \frac{PS}{0.66S+12.4}$		$M = \frac{PS}{0.66S+17.05}$		$M = \frac{PS}{0.66S+20.15}$		$M = \frac{PS}{0.66S+24.8}$	
		S	I	M	M × (1.0+I)	M	M × (1.0+I)	M	M × (1.0+I)
2.0	0.394	2,330	3,250	1,750	2,440	1,490	2,080	1,230	1,710
2.5	.392	2,850	3,970	2,130	2,970	1,840	2,560	1,510	2,100
3.0	.391	3,340	4,640	2,520	3,510	2,170	3,030	1,790	2,490
3.5	.390	3,800	5,280	2,890	4,030	2,490	3,470	2,070	2,870
4.0	.388	4,250	5,900	3,250	4,520	2,800	3,890	2,330	3,240
4.5	.386	4,690	6,500	3,600	4,980	3,110	4,310	2,590	3,600
5.0	.385	5,100	7,060	3,930	5,450	3,410	4,720	2,850	3,950
5.5	.383	5,490	7,580	4,250	5,880	3,700	5,110	3,100	4,290
6.0	.382	5,870	8,110	4,570	6,320	3,980	5,500	3,340	4,630
6.5	.380	6,240	8,620	4,870	6,720	4,250	5,860	3,580	4,930
7.0	.379	6,570	9,080	5,160	7,120	4,520	6,220	3,810	5,240

TABLE 10.—Design moments, dimensions, and reinforcement of slabs for the following conditions <sup>1</sup>

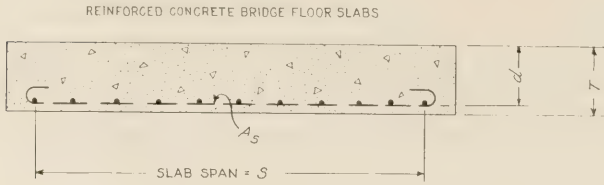

Controlling conditions:

- H-15 loading.
- Case I—parallel reinforcement.
- Freely supported slabs.
- All truck lanes.
- Paving allowance 25 pounds per square foot.
- Modified formulas.
- A<sub>s</sub> = Area of tension reinforcement.
- d = T - 1.25 inches for bars 5/8 inch and under.
- d = T - 1.50 inches for bars over 5/8 inch.
- All bars to be hooked at ends.

Slab span S	Slab depth T	Bar size <sup>2</sup>	Bar space center-to-center	Dead load moment $\frac{WS^2}{8}$	M (1.0+I)	M <sub>t</sub>	A <sub>s</sub>	ρ	k	j	Unit stress	
											f <sub>s</sub>	f <sub>c</sub>
Feet	Inches	Inch	Inches	Ft.-lb.	Ft.-lb.	Ft.-lb.	Sq. in.				Lb./sq. in.	Lb./sq. in.
2	5.75	1/2 R	5.5	40	2,440	2,480	0.43	0.0079	0.351	0.883	17,400	790
3	6.75	5/8 R	7.5	120	3,480	3,600	.49	.0074	.342	.886	18,100	780
4	7.50	5/8 R	6.5	240	4,430	4,670	.57	.0076	.345	.885	17,750	780
5	8.0	5/8 R	5.5	390	5,300	5,690	.67	.0083	.358	.881	17,200	795
6	8.5	5/8 R	5.0	590	6,080	6,670	.74	.0085	.361	.880	17,100	800
7	9.25	5/8 R	5.0	860	6,810	7,670	.74	.0077	.347	.884	17,700	780
8	9.3	5/8 R	4.5	1,150	7,460	8,610	.82	.0083	.358	.881	17,400	805
9	10.25	5/8 R	4.5	1,550	8,085	9,635	.82	.0076	.345	.885	17,700	780
10	10.75	3/4 R	6.0	2,000	8,645	10,645	.88	.0080	.353	.882	17,800	810
11	11.0	3/4 R	5.5	2,455	9,165	11,620	.96	.0084	.360	.880	17,350	810
12	12.0	3/4 R	5.5	3,150	9,680	12,830	.96	.0076	.345	.885	17,250	760
13	12.0	7/8 R	7.0	3,700	10,140	13,840	1.03	.0082	.356	.881	17,500	800
14	12.5	7/8 R	7.0	4,440	10,550	14,990	1.03	.0078	.349	.884	18,000	800
15	13.0	7/8 R	6.5	5,290	10,960	16,250	1.11	.0080	.353	.882	17,300	790
16	13.5	7/8 R	6.5	6,210	11,330	17,540	1.11	.0077	.347	.884	17,900	795
17	14.0	7/8 R	6.0	7,230	11,670	18,900	1.20	.0089	.353	.882	17,100	780
18	14.5	7/8 R	6.0	8,350	12,000	20,350	1.20	.0077	.347	.884	17,700	785
19	15.0	1 R	7.5	9,620	12,330	21,950	1.26	.0078	.349	.884	17,500	780
20	15.5	1 R	7.5	10,950	12,600	23,550	1.26	.0075	.344	.886	18,100	790
21	16.0	1 R	7.0	12,400	12,880	25,280	1.35	.0077	.347	.884	17,600	785
22	16.5	1 R	7.0	13,980	13,150	27,130	1.35	.0075	.344	.886	18,150	795
23	17.0	1 R	6.5	15,720	13,370	29,090	1.45	.0078	.349	.884	17,600	780
24	17.5	1 R	6.5	17,570	13,630	31,200	1.45	.0076	.345	.885	18,200	800
25	18.0	1 R	6.0	19,530	13,840	33,370	1.57	.0079	.351	.883	17,500	790

<sup>1</sup> See table 2 for reinforcement transverse to the main reinforcement and table 7 for edge support requirements.

<sup>2</sup> In this and subsequent tables R is used to designate round bars.

TABLE 11.—Design moments, dimensions, and reinforcement of slabs for the following conditions <sup>1</sup>

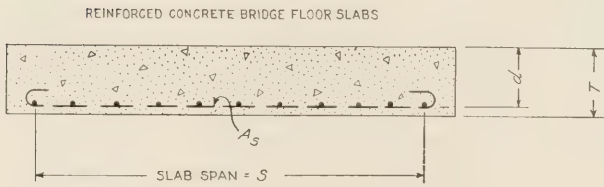

Controlling conditions:

- H-15 loading.
- Case I—parallel reinforcement.
- Freely supported slabs.
- All truck lanes.
- Paving allowance, 75 pounds per square foot.
- Modified formulas.
- A<sub>s</sub> = Area of tension reinforcement.
- d = T - 1.25 inches for bars 3/4 inch and under.
- d = T - 1.50 inches for bars over 3/4 inch.
- All bars to be hooked at ends.

Slab span S	Slab depth T	Bar size	Bar space center-to-center	Dead load moment $\frac{WS^2}{8}$	M (1.0+I)	M <sub>t</sub>	A <sub>s</sub>	ρ	k	j	Unit stress	
											f <sub>s</sub>	f <sub>c</sub>
Feet	Inches	Inch	Inches	Ft.-lb.	Ft.-lb.	Ft.-lb.	Sq. in.				Lb./sq. in.	Lb./sq. in.
2	5.75	1/2 R	5.5	70	2,440	2,510	0.43	0.0079	0.351	0.883	17,600	800
3	6.75	5/8 R	7.0	180	3,480	3,690	.53	.0080	.353	.882	17,100	780
4	7.50	5/8 R	6.5	340	4,430	4,770	.57	.0076	.345	.885	18,200	800
5	8.25	5/8 R	5.5	560	5,300	5,860	.67	.0080	.353	.882	17,000	770
6	8.75	5/8 R	5.0	830	6,080	6,910	.74	.0082	.356	.881	17,000	780
7	9.5	5/8 R	5.0	1,190	6,810	8,000	.74	.0075	.344	.886	17,750	775
8	9.75	5/8 R	4.5	1,570	7,460	9,030	.82	.0080	.353	.882	17,600	800
9	10.5	3/4 R	6.0	2,085	8,085	10,170	.88	.0082	.356	.881	17,500	800
10	11.0	3/4 R	5.5	2,655	8,645	11,300	.96	.0084	.360	.880	16,900	790
11	11.5	3/4 R	5.5	3,315	9,165	12,480	.96	.0080	.353	.882	17,700	805
12	12.0	7/8 R	7.0	4,050	9,680	13,730	1.03	.0082	.356	.881	17,300	795
13	12.5	7/8 R	7.0	4,880	10,140	15,020	1.03	.0078	.349	.884	18,000	805
14	13.0	7/8 R	6.5	5,830	10,550	16,380	1.11	.0080	.353	.882	17,500	795
15	13.5	7/8 R	6.5	6,860	10,960	17,820	1.11	.0077	.347	.884	18,200	805
16	14.0	7/8 R	6.0	8,000	11,330	19,330	1.18	.0080	.353	.882	17,550	800
17	14.5	7/8 R	6.0	9,250	11,670	20,920	1.20	.0077	.347	.884	18,200	805
18	15.0	1 R	7.5	10,650	12,000	22,650	1.26	.0078	.349	.884	18,100	805
19	15.5	1 R	7.0	12,140	12,330	24,470	1.35	.0080	.353	.882	17,600	800
20	16.0	1 R	6.5	13,750	12,600	26,350	1.45	.0083	.358	.881	17,100	795
21	16.5	1 R	6.5	15,480	12,880	28,360	1.45	.0081	.354	.882	17,800	810
22	17.0	1 R	6.0	17,390	13,150	30,540	1.57	.0085	.361	.880	17,100	800
23	17.5	1 R	6.0	19,440	13,370	32,810	1.57	.0082	.356	.881	17,700	810
24	18.0	1 R	5.5	21,600	13,630	35,230	1.71	.0086	.363	.879	17,000	805
25	19.0	1 R	5.5	24,460	13,840	38,300	1.71	.0082	.356	.881	17,400	800

<sup>1</sup> See table 2 for reinforcement transverse to the main reinforcement and table 7 for edge support requirements.

TABLE 12.—Design moments, dimensions, and reinforcement of slabs for the following conditions <sup>1</sup>

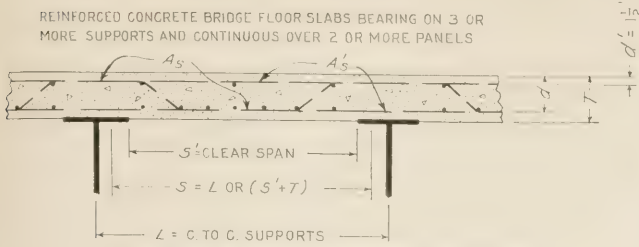

Spans 2 to 3.5 feet, inclusive,  $A'_s = A_s$ , bars not bent.  
 Spans 4 to 10 feet, inclusive,  $A'_s = 0.5 A_s$ , bars bent as shown.

Controlling conditions:

- H-15 loading.
- Case I—parallel reinforcement.
- Slabs continuous.
- 50 percent end restraint.
- All truck lanes.
- Paving allowance 25 pounds per square foot.
- Modified formulas.
- $A_s$  = Area of tension reinforcement.
- $A'_s$  = Area of compression reinforcement.
- $d = T - 1.25$  inches for bars  $\frac{3}{8}$  inch or under.
- $d = T - 1.50$  inches for bars over  $\frac{3}{8}$  inch.
- All bars to be hooked at ends.

Slab span <i>S</i>	Slab depth <i>T</i>	Bar size	Bar space center-to-center	Dead load moment $\frac{WS^2}{10}$	$M(1.0+I)$	$M_t$	$A_s$	$p$	$\frac{d'}{d}$	$k$	$j$	Unit stress	
												$f_s$	$f_c$
<i>Feet</i>	<i>Inches</i>	<i>Inch</i>	<i>Inches</i>	<i>Ft.-lb.</i>	<i>Ft.-lb.</i>	<i>Ft.-lb.</i>	<i>Sq. in.</i>					<i>Lb./sq. in.</i>	<i>Lb./sq. in.</i>
2.0	5.25	$\frac{1}{2}$ R	6.5	35	1,830	1,865	0.36	0.0075		0.344	0.886	17,500	770
2.5	5.75	$\frac{1}{2}$ R	6.0	60	2,230	2,290	.39	.0072	0.333	.338	.887	17,600	750
3.0	6.0	$\frac{1}{2}$ R	5.5	90	2,630	2,720	.43	.0075	.316	.338	.880	18,200	770
3.5	6.25	$\frac{5}{8}$ R	7.5	130	3,020	3,150	.49	.0082	.300	.346	.872	17,700	780
4.0	6.5	$\frac{5}{8}$ R	7.0	170	3,390	3,560	.53	.0084	.286	.352	.875	17,550	795
4.5	6.75	$\frac{5}{8}$ R	6.5	220	3,740	3,960	.57	.0086	.273	.353	.872	17,350	795
5.0	7.0	$\frac{5}{8}$ R	6.0	280	4,090	4,370	.61	.0088	.261	.355	.871	17,100	790
5.5	7.25	$\frac{5}{8}$ R	6.0	350	4,410	4,760	.61	.0085	.250	.350	.872	17,800	800
6.0	7.5	$\frac{5}{8}$ R	5.5	430	4,740	5,170	.67	.0089	.240	.355	.871	17,000	780
6.5	7.75	$\frac{5}{8}$ R	5.5	520	5,040	5,560	.67	.0086	.231	.349	.873	17,600	785
7.0	7.75	$\frac{5}{8}$ R	5.0	600	5,340	5,940	.74	.0095	.231	.361	.868	17,050	805
7.5	8.0	$\frac{5}{8}$ R	5.0	700	5,630	6,330	.74	.0091	.222	.355	.871	17,450	805
8.0	8.25	$\frac{5}{8}$ R	5.0	820	5,920	6,740	.74	.0088	.214	.350	.873	17,900	805
8.5	8.5	$\frac{5}{8}$ R	4.5	950	6,190	7,140	.82	.0094	.207	.358	.870	16,600	770
9.0	8.5	$\frac{5}{8}$ R	4.5	1,060	6,450	7,510	.82	.0094	.207	.358	.870	17,400	810
9.5	8.75	$\frac{5}{8}$ R	4.5	1,210	6,710	7,920	.82	.0091	.200	.353	.872	17,700	805
10.0	9.0	$\frac{5}{8}$ R	4.5	1,380	6,950	8,330	.82	.0088	.194	.348	.874	18,000	800
11.0	9.5	$\frac{3}{4}$ R	6.0	1,750	7,420	9,170	.88	.0092	.188	.353	.873	17,900	810
12.0	9.75	$\frac{3}{4}$ R	5.5	2,120	7,870	9,990	.96	.0097	.182	.359	.871	17,400	810
13.0	10.25	$\frac{3}{4}$ R	5.5	2,590	8,290	10,880	.96	.0092	.171	.351	.875	17,800	800
14.0	10.5	$\frac{3}{4}$ R	7.0	3,060	8,690	11,750	1.03	.0095	.167	.356	.874	17,400	800
15.0	11.0	$\frac{3}{4}$ R	7.0	3,670	9,060	12,730	1.03	.0090	.158	.348	.878	17,800	790
16.0	11.5	$\frac{3}{4}$ R	7.0	4,330	9,420	13,750	1.03	.0086	.150	.341	.882	18,150	785
17.0	11.5	$\frac{3}{4}$ R	6.5	4,880	9,760	14,640	1.11	.0092	.150	.350	.879	18,000	805
18.0	12.0	$\frac{3}{4}$ R	6.0	5,680	10,080	15,760	1.20	.0095	.143	.353	.878	17,100	775
19.0	12.0	1 R	7.5	6,330	10,380	16,710	1.26	.0100	.143	.358	.877	17,300	805
20.0	12.5	1 R	7.5	7,250	10,670	17,920	1.26	.0095	.136	.352	.879	17,700	800
21.0	13.0	1 R	7.5	8,270	10,940	19,210	1.26	.0091	.130	.346	.882	18,100	795
22.0	13.0	1 R	7.0	9,080	11,190	20,270	1.35	.0098	.130	.354	.880	17,800	810
23.0	13.5	1 R	7.0	10,250	11,460	21,710	1.35	.0094	.125	.348	.884	18,200	810
24.0	14.0	1 R	6.5	11,530	11,700	23,230	1.45	.0097	.120	.352	.883	17,400	790
25.0	14.5	1 R	6.5	12,880	11,920	24,800	1.45	.0093	.115	.347	.885	17,800	780

<sup>1</sup> See table 2 for reinforcement transverse to main reinforcement and table 7 for edge support requirements.

TABLE 13.—Design moments, dimensions, and reinforcement of slabs for the following conditions <sup>1</sup>

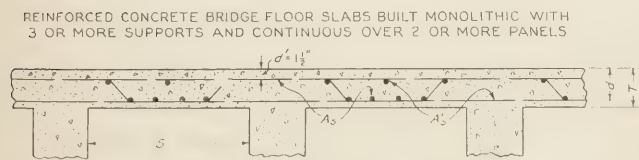

Spans 2 to 3.5 feet inclusive,  $A'_s = A_s$ , bars not bent.  
 Spans 4 to 10 feet inclusive,  $A'_s = 0.5 A_s$ , bars bent as shown.

Controlling conditions:

- H-15 loading.
- Case I—parallel reinforcement.
- Slabs monolithic.
- 75 percent end restraint.
- All truck lanes.
- Paving allowance 25 pounds per square foot.
- Modified formulas.
- $A_s$  = Area of tension reinforcement.
- $A'_s$  = Area of compression reinforcement.
- $d = T - 1.25$  inches for bars  $\frac{3}{8}$  inch or under.
- $d = T - 1.50$  inches for bars over  $\frac{3}{8}$  inch.
- All bars to be hooked at ends.

Slab span <i>S</i>	Slab depth <i>T</i>	Bar size	Bar space center-to-center	Dead load moment $\frac{WS^2}{10}$	$M(1.0+I)$	$M_t$	$A_s$	$p$	$\frac{d'}{d}$	$k$	$j$	Unit stress	
												$f_s$	$f_c$
<i>Feet</i>	<i>Inches</i>	<i>Inch</i>	<i>Inches</i>	<i>Ft.-lb.</i>	<i>Ft.-lb.</i>	<i>Ft.-lb.</i>	<i>Sq. in.</i>					<i>Lb./sq. in.</i>	<i>Lb./sq. in.</i>
2.0	5.0	$\frac{1}{2}$ R	7.0	30	1,560	1,590	0.34	0.0075		0.344	0.886	16,900	750
2.5	5.25	$\frac{1}{2}$ R	6.0	60	1,920	1,980	.39	.0081		.354	.882	17,300	790
3.0	5.75	$\frac{1}{2}$ R	6.0	90	2,270	2,360	.39	.0072	0.333	.338	.887	18,200	775
3.5	6.0	$\frac{1}{2}$ R	5.5	120	2,600	2,720	.43	.0075	.316	.338	.880	18,200	770
4.0	6.25	$\frac{5}{8}$ R	7.5	170	2,920	3,090	.49	.0082	.300	.350	.876	17,300	775
4.5	6.5	$\frac{5}{8}$ R	7.0	220	3,230	3,450	.53	.0084	.286	.352	.875	17,000	770
5.0	6.75	$\frac{5}{8}$ R	7.0	280	3,540	3,820	.53	.0080	.273	.345	.876	17,950	790
5.5	7.00	$\frac{5}{8}$ R	6.5	340	3,830	4,170	.57	.0083	.261	.347	.874	17,500	775
6.0	7.25	$\frac{5}{8}$ R	6.5	420	4,130	4,550	.57	.0079	.250	.341	.877	18,000	780
6.5	7.25	$\frac{5}{8}$ R	5.5	490	4,400	4,890	.67	.0093	.250	.361	.868	16,800	790
7.0	7.5	$\frac{5}{8}$ R	5.5	580	4,670	5,250	.67	.0089	.240	.355	.871	17,300	795
7.5	7.75	$\frac{5}{8}$ R	5.5	690	4,950	5,640	.67	.0086	.231	.349	.873	17,800	800
8.0	7.75	$\frac{5}{8}$ R	5.0	780	5,200	5,950	.74	.0095	.231	.361	.868	17,200	810
8.5	8.0	$\frac{5}{8}$ R	5.0	910	5,450	6,360	.74	.0091	.222	.355	.871	17,550	805
9.0	8.25	$\frac{5}{8}$ R	5.0	1,040	5,670	6,710	.74	.0088	.214	.350	.873	17,800	800
9.5	8.5	$\frac{5}{8}$ R	5.0	1,190	5,920	7,110	.74	.0085	.207	.345	.875	18,200	800
10.0	8.5	$\frac{5}{8}$ R	4.5	1,320	6,140	7,460	.82	.0094	.207	.358	.870	17,300	805

<sup>1</sup> See table 2 for reinforcement transverse to main reinforcement and table 7 for edge support requirements.

TABLE 13.—Design moments, dimensions, and reinforcement of slabs for the following conditions—Continued

Slab span S	Slab depth T	Bar size	Bar space center-to-center	Dead load moment $\frac{WS^2}{10}$	$M(1.0+I)$	$M_t$	$A_s$	p	$\frac{d'}{d}$	k	j	Unit stress	
												$f_s$	$f_c$
Feet	Inches	Inch	Inches	Ft.-lb.	Ft.-lb.	Ft.-lb.	Sq. in.					Lb./sq. in.	Lb./sq. in.
11.0	9.0	$\frac{5}{8}$ R	4.5	1,660	6,580	8,240	0.82	0.0088	0.194	0.348	0.874	17,800	790
12.0	9.5	$\frac{5}{8}$ R	6.0	2,080	7,000	9,080	.88	.0092	.188	.353	.873	17,700	800
13.0	10.0	$\frac{5}{8}$ R	6.0	2,540	7,370	9,910	.88	.0087	.177	.345	.876	18,150	790
14.0	10.25	$\frac{5}{8}$ R	5.5	3,000	7,750	10,750	.96	.0092	.171	.351	.875	17,500	790
15.0	10.5	$\frac{5}{8}$ R	7.0	3,510	8,100	11,610	1.03	.0095	.167	.356	.874	17,200	790
16.0	11.0	$\frac{5}{8}$ R	7.0	4,170	8,460	12,630	1.03	.0090	.158	.348	.878	17,600	785
17.0	11.0	$\frac{5}{8}$ R	6.5	4,710	8,780	13,490	1.11	.0097	.158	.356	.875	17,600	810
18.0	11.5	$\frac{5}{8}$ R	6.5	5,480	9,070	14,550	1.11	.0092	.150	.350	.879	17,900	800
19.0	11.5	1 R	7.5	6,100	9,370	15,470	1.26	.0105	.150	.365	.874	16,850	805
20.0	12.0	1 R	7.5	7,000	9,640	16,640	1.26	.0100	.143	.358	.877	17,200	800
21.0	12.5	1 R	7.5	7,980	9,900	17,880	1.26	.0095	.136	.352	.879	17,600	800
22.0	13.0	1 R	7.5	9,090	10,180	19,270	1.26	.0091	.130	.346	.882	18,100	795
23.0	13.0	1 R	7.0	9,950	10,430	20,380	1.35	.0098	.130	.354	.880	17,900	810
24.0	13.5	1 R	6.5	11,180	10,660	21,840	1.45	.0101	.125	.357	.879	17,200	790
25.0	14.0	1 R	6.5	12,500	10,880	23,380	1.45	.0097	.120	.352	.883	17,600	790

TABLE 14.—Design moments, dimensions, and reinforcement of slabs for the following conditions <sup>1</sup>

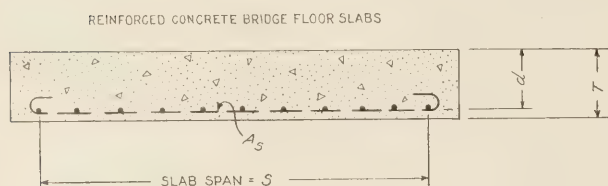

Controlling conditions:  
 H-20 loading.  
 Case I—parallel reinforcement.  
 Freely supported slabs.  
 All truck lanes.  
 Paving allowance, 25 pounds per square foot.  
 Modified formulas.  
 $A_s$  = Area of tension reinforcement.  
 $d = T - 1.25$  inches for bars  $\frac{5}{8}$  inch and under.  
 $d = T - 1.50$  inches for bars over  $\frac{5}{8}$  inch.  
 All bars to be hooked at ends.

Slab span S	Slab depth T	Bar size	Bar space, center-to-center	Dead-load moment $\frac{WS^2}{8}$	$M(1.0+I)$	$M_t$	$A_s$	p	k	j	Unit stress	
											$f_s$	$f_c$
Feet	Inches	Inch	Inches	Ft.-lb.	Ft.-lb.	Ft.-lb.	Sq. in.				Lb./sq. in.	Lb./sq. in.
2	6.5	$\frac{1}{4}$ R	5.0	50	3,250	3,300	0.47	0.0075	0.344	0.886	18,050	790
3	7.5	$\frac{1}{4}$ R	6.5	140	4,640	4,780	.57	.0076	.345	.885	18,100	800
4	8.25	$\frac{1}{4}$ R	5.5	260	5,900	6,160	.67	.0080	.353	.882	17,900	810
5	9.0	$\frac{1}{4}$ R	5.0	430	7,060	7,490	.74	.0079	.351	.883	17,800	800
6	9.75	$\frac{1}{4}$ R	4.5	660	8,110	8,770	.82	.0080	.353	.882	17,200	780
7	10.5	$\frac{1}{4}$ R	4.5	950	9,080	1,030	.82	.0074	.342	.886	17,900	775
8	11.0	$\frac{1}{4}$ R	6.0	1,300	9,940	11,240	.88	.0077	.347	.884	18,200	810
9	11.5	$\frac{1}{4}$ R	5.5	1,710	10,770	12,480	.96	.0080	.353	.882	17,650	800
10	12.0	$\frac{1}{4}$ R	7.0	2,190	11,520	13,710	1.03	.0082	.356	.881	17,300	790
11	12.5	$\frac{1}{4}$ R	7.0	2,740	12,210	14,950	1.03	.0078	.349	.884	17,900	800
12	13.0	$\frac{1}{4}$ R	6.5	3,380	12,900	16,280	1.11	.0080	.353	.882	17,400	790
13	13.5	$\frac{1}{4}$ R	6.5	4,100	13,520	17,620	1.11	.0077	.347	.884	17,950	800
14	14.0	$\frac{1}{4}$ R	6.0	4,900	14,060	18,960	1.20	.0080	.353	.882	17,150	780
15	14.5	$\frac{1}{4}$ R	6.0	5,790	14,610	20,400	1.20	.0077	.347	.884	17,700	790
16	14.5	$\frac{1}{4}$ R	5.5	6,590	15,100	21,690	1.31	.0084	.360	.880	17,300	810
17	15.0	$\frac{1}{4}$ R	5.5	7,670	15,550	23,220	1.31	.0081	.354	.882	17,800	810
18	15.5	1 R	7.0	8,860	16,000	24,360	1.35	.0080	.353	.882	17,900	810
19	16.0	1 R	6.5	10,150	16,440	26,590	1.45	.0083	.358	.881	17,200	800
20	16.5	1 R	6.5	11,540	16,800	28,340	1.45	.0080	.353	.882	17,750	810
21	17.0	1 R	6.0	13,100	17,180	30,280	1.57	.0084	.360	.880	17,000	795
22	17.5	1 R	6.0	14,770	17,540	32,310	1.57	.0082	.356	.881	17,500	805
23	18.0	1 R	6.0	16,530	17,830	34,360	1.57	.0079	.351	.883	18,000	810
24	18.5	1 R	5.5	18,430	18,170	36,600	1.71	.0084	.360	.880	17,200	805
25	19.0	1 R	5.5	20,500	18,450	38,950	1.71	.0082	.356	.881	17,700	810

<sup>1</sup> See table 2 for reinforcement transverse to main reinforcement and table 9 for edge support requirements.



TABLE 15.—Design moments, dimensions, and reinforcement for the following conditions <sup>1</sup>

Controlling conditions:

- H-20 loading.
- Case I—parallel reinforcement.
- Freely supported slabs.
- All truck lanes.
- Paving allowance, 75 pounds per square foot.
- Modified formulas.
- $A_s$  = Area of tension reinforcement.
- $d = T - 1.25$  inches for bars  $\frac{5}{8}$  inch and under.
- $d = T - 1.50$  inches for bars over  $\frac{5}{8}$  inch.
- All bars to be hooked at ends.

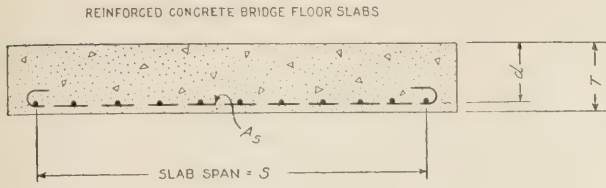

Slab span, S	Slab depth, T	Bar size	Bar space, center-to-center	Dead-load moment $\frac{WS^2}{8}$	$M(1.0+I)$	$M_t$	$A_s$	$p$	$k$	$j$	Unit stress	
											$f_s$	$f_c$
Feet	Inches	Inch	Inches	Ft.-lb.	Ft.-lb.	Ft.-lb.	Sq. in.				Lb./sq. in.	Lb./sq. in.
2	6.5	1/2 R	5.0	80	3,250	3,330	0.47	0.0075	0.344	0.886	18,200	795
3	7.5	5/8 R	6.0	190	4,640	4,830	.61	.0082	.356	.881	17,250	790
4	8.5	5/8 R	5.5	360	5,900	6,260	.67	.0077	.347	.884	17,500	775
5	9.25	5/8 R	5.0	600	7,060	7,660	.74	.0077	.347	.884	17,550	780
6	9.75	5/8 R	4.5	890	8,110	9,000	.82	.0080	.353	.882	17,600	800
7	10.5	3/4 R	6.0	1,260	9,080	10,340	.88	.0082	.356	.881	17,700	810
8	11.0	3/4 R	5.5	1,700	9,940	11,640	.96	.0084	.360	.880	17,300	810
9	12.0	3/4 R	5.5	2,280	10,770	13,050	.96	.0076	.345	.885	17,500	775
10	12.5	3/4 R	7.0	2,890	11,520	14,410	1.03	.0078	.349	.884	17,250	770
11	13.0	7/8 R	7.0	3,600	12,210	15,810	1.03	.0075	.344	.886	18,050	785
12	13.0	7/8 R	6.0	4,280	12,900	17,180	1.20	.0087	.365	.878	17,000	810
13	13.5	7/8 R	5.5	5,150	13,520	18,670	1.31	.0091	.371	.876	16,200	800
14	14.0	7/8 R	5.5	6,130	14,060	20,190	1.31	.0087	.365	.878	16,800	805
15	14.5	7/8 R	5.5	7,200	14,610	21,810	1.31	.0084	.360	.880	17,400	810
16	15.0	1 R	7.0	8,400	15,100	23,500	1.35	.0083	.358	.881	17,550	810
17	15.5	1 R	6.5	9,710	15,550	25,260	1.45	.0086	.363	.879	17,000	805
18	16.5	1 R	6.5	11,380	16,000	27,380	1.45	.0080	.353	.882	17,100	780
19	17.0	1 R	6.5	12,980	16,440	29,420	1.45	.0078	.349	.884	17,800	795
20	17.5	1 R	6.0	14,700	16,800	31,500	1.57	.0082	.356	.881	17,100	785
21	18.0	1 R	6.0	16,540	17,180	33,720	1.57	.0079	.351	.883	17,650	795
22	18.5	1 R	5.5	18,500	17,540	36,040	1.71	.0084	.360	.880	16,900	790
23	19.0	1 R	5.5	20,670	17,830	38,500	1.71	.0082	.356	.881	17,500	800
24	19.5	1 R	5.5	22,960	18,170	41,130	1.71	.0079	.351	.883	18,100	810
25	20.0	1 S	6.5	25,400	18,450	43,850	1.85	.0083	.358	.881	17,500	810

<sup>1</sup> See table 2 for reinforcement transverse to main reinforcement and table 9 for edge support requirements.  
<sup>2</sup> S is used here to denote square bars.

TABLE 16.—Design moments, dimensions, and reinforcement of slabs for the following conditions <sup>1</sup>

Controlling conditions:

- H-20 loading.
- Case I—parallel reinforcement.
- Slabs continuous.
- 50 percent end restraint.
- All truck lanes.
- Paving allowance 25 pounds per square foot.
- Modified formulas.
- $A_s$  = Area of tension reinforcement.
- $A'_s$  = Area of compression reinforcement.
- $d = T - 1.25$  inches for bars  $\frac{5}{8}$  inch or under.
- $d = T - 1.50$  inches for bars over  $\frac{5}{8}$  inch.
- All bars to be hooked at ends.

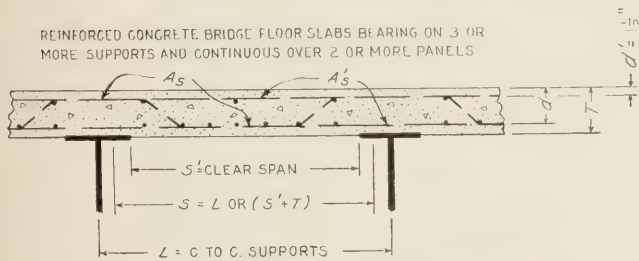

Spans 2 to 3.5 feet, inclusive,  $A'_s = A_s$ , bars not bent.  
 Spans 4 to 10 feet, inclusive,  $A'_s = 0.5 A_s$ , bars bent as shown.

Slab span S	Slab depth T	Bar size	Bar space, center-to-center	Dead-load moment $\frac{WS^2}{10}$	$M(1.0+I)$	$M_t$	$A_s$	$p$	$\frac{d'}{d}$	$k$	$j$	Unit stress	
												$f_s$	$f_c$
Feet	Inches	Inch	Inches	Ft.-lb.	Ft.-lb.	Ft.-lb.	Sq. in.					Lb./sq. in.	Lb./sq. in.
2.0	5.75	1/2 R	5.5	40	2,440	2,480	0.43	0.0080	0.333	0.349	0.878	17,600	785
2.5	6.25	5/8 R	8.0	60	2,970	3,030	.46	.0077	.300	.338	.877	18,000	770
3.0	6.5	5/8 R	7.0	100	3,510	3,610	.53	.0084	.286	.346	.868	17,900	790
3.5	6.75	5/8 R	6.0	130	4,030	4,160	.61	.0093	.273	.355	.862	17,200	785
4.0	7.25	5/8 R	6.0	180	4,520	4,700	.61	.0085	.250	.350	.872	17,700	790
4.5	7.5	5/8 R	5.5	240	4,980	5,220	.67	.0089	.240	.355	.871	17,200	790
5.0	7.75	5/8 R	5.5	310	5,450	5,760	.67	.0086	.231	.349	.873	18,200	810
5.5	8.0	5/8 R	5.0	380	5,880	6,260	.74	.0091	.222	.355	.871	17,250	795
6.0	8.25	5/8 R	5.0	460	6,320	6,780	.74	.0088	.214	.350	.873	18,000	810
6.5	8.5	5/8 R	4.5	550	6,720	7,270	.82	.0094	.207	.358	.870	16,900	785
7.0	8.75	5/8 R	4.5	660	7,120	7,780	.82	.0091	.200	.353	.872	17,400	790
7.5	9.0	5/8 R	4.5	780	7,510	8,290	.82	.0088	.194	.348	.874	17,900	800
8.0	9.5	5/8 R	4.5	920	7,900	8,820	.82	.0083	.182	.340	.877	17,800	765
8.5	9.75	3/4 R	6.0	1,060	8,250	9,310	.88	.0089	.182	.348	.875	17,500	780
9.0	9.75	3/4 R	5.5	1,190	8,600	9,790	.96	.0097	.182	.359	.871	17,000	790
9.5	10.0	3/4 R	5.5	1,360	8,940	10,300	.96	.0094	.177	.354	.874	17,300	790
10.0	10.25	3/4 R	5.5	1,530	9,260	10,790	.96	.0092	.171	.351	.875	17,600	790
11.0	10.5	7/8 R	7.0	1,890	9,900	11,790	1.03	.0095	.167	.356	.874	17,500	800
12.0	11.0	7/8 R	7.0	2,340	10,490	12,830	1.03	.0090	.158	.348	.878	17,900	795
13.0	11.5	7/8 R	6.5	2,860	11,050	13,910	1.11	.0092	.150	.350	.879	17,100	770
14.0	11.5	7/8 R	6.0	3,310	11,580	14,890	1.20	.0100	.150	.359	.875	17,000	795
15.0	12.0	7/8 R	6.0	3,940	12,080	16,020	1.20	.0095	.143	.353	.878	17,300	785
16.0	12.0	1 R	7.5	4,480	12,550	17,030	1.26	.0100	.143	.358	.877	17,600	810
17.0	12.5	1 R	7.5	5,230	13,000	18,230	1.26	.0095	.136	.352	.879	18,000	810

<sup>1</sup> See table 2 for reinforcement transverse to main reinforcement and table 9 for edge support requirements.

TABLE 16.—Design moments, dimensions, and reinforcement of slabs for the following conditions—Continued

Slab span <i>S</i>	Slab depth <i>T</i>	Bar size	Bar space, center-to-center	Dead load moment $\frac{WS^2}{10}$	$M(1.0+I)$	$M_t$	$A_s$	$p$	$\frac{d'}{d}$	$k$	$j$	Unit stress	
												$f_s$	$f_c$
Feet	Inches	Inch	Inches	Ft.-lb.	Ft.-lb.	Ft.-lb.	Sq. in.					Lb./sq. in.	Lb./sq. in.
18.0	13.0	1R	7.0	6,070	13,440	19,510	1.35	0.0098	0.130	0.354	0.880	17,200	785
19.0	13.0	1R	6.5	6,770	13,840	20,610	1.45	.0105	.130	.363	.878	16,900	800
20.0	13.5	1R	6.5	7,720	14,230	21,950	1.45	.0101	.125	.357	.879	17,200	795
21.0	14.0	1R	6.5	8,820	14,580	23,400	1.45	.0097	.120	.352	.883	17,600	790
22.0	14.0	1R	6.0	9,680	14,910	24,590	1.57	.0105	.120	.361	.880	17,100	805
23.0	14.5	1R	6.0	10,900	15,250	26,180	1.57	.0101	.115	.356	.881	17,500	800
24.0	15.0	1R	6.0	12,240	15,600	27,840	1.57	.0097	.111	.351	.884	17,800	800
25.0	15.5	1R	6.0	13,680	15,900	29,580	1.57	.0093	.107	.346	.887	18,200	805

TABLE 17.—Design moments, dimensions, and reinforcement of slabs for the following conditions <sup>1</sup>

REINFORCED CONCRETE BRIDGE FLOOR SLABS BUILT MONOLITHIC WITH 3 OR MORE SUPPORTS AND CONTINUOUS OVER 2 OR MORE PANELS

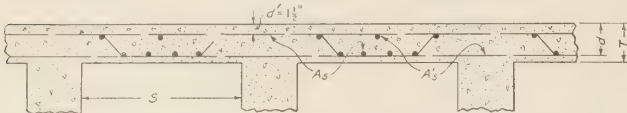

Spans 2 to 3.5 feet inclusive,  $A'_s = A_s$ , bars not bent.  
Spans 4 to 10 feet inclusive,  $A'_s = 0.5 A_s$ , bars bent as shown.

Controlling conditions:

- H*-20 loading.
- Case I—parallel reinforcement.
- Slabs monolithic.
- 75 percent end restraint.
- All truck lanes.
- Paving allowance 25 pounds per square foot.
- Modified formulas.
- $A_s$  = Area of tension reinforcement.
- $A'_s$  = Area of compression reinforcement.
- $d = T - 1.25$  inches for bars  $\frac{5}{8}$  inch or under.
- $d = T - 1.50$  inches for bars over  $\frac{5}{8}$  inch.
- All bars to be hooked at ends.

Slab span <i>S</i>	Slab depth <i>T</i>	Bar size	Bar space, center-to-center	Dead load moment $\frac{WS^2}{10}$	$M(1.0+I)$	$M_t$	$A_s$	$p$	$\frac{d'}{d}$	$k$	$j$	Unit stress	
												$f_s$	$f_c$
Feet	Inches	Inch	Inches	Ft.-lb.	Ft.-lb.	Ft.-lb.	Sq.-in.					Lb./sq. in.	Lb./sq. in.
2.0	5.5	$\frac{1}{2}$ R	6.0	40	2,080	2,120	0.39	0.0076		0.345	0.885	17,300	765
2.5	5.75	$\frac{1}{2}$ R	5.0	60	2,560	2,620	.47	.0087	0.333	.359	.872	17,000	795
3.0	6.25	$\frac{3}{4}$ R	7.5	90	3,030	3,120	.49	.0082	.300	.346	.872	17,500	770
3.5	6.5	$\frac{3}{4}$ R	7.0	130	3,470	3,600	.53	.0084	.286	.346	.868	17,900	790
4.0	6.75	$\frac{3}{4}$ R	6.5	170	3,890	4,060	.57	.0086	.273	.353	.872	17,800	810
4.5	7.25	$\frac{3}{4}$ R	6.5	240	4,310	4,560	.57	.0079	.250	.341	.877	18,000	780
5.0	7.25	$\frac{3}{4}$ R	5.5	290	4,720	5,010	.67	.0093	.250	.361	.868	17,300	810
5.5	7.5	$\frac{3}{4}$ R	5.0	360	5,110	5,470	.74	.0098	.240	.367	.866	16,500	790
6.0	7.75	$\frac{3}{4}$ R	5.0	440	5,500	5,940	.74	.0095	.231	.361	.868	17,050	805
6.5	8.0	$\frac{3}{4}$ R	5.0	530	5,860	6,390	.74	.0091	.222	.355	.871	17,700	810
7.0	8.25	$\frac{3}{4}$ R	4.5	630	6,220	6,850	.82	.0097	.214	.363	.868	16,500	785
7.5	8.5	$\frac{3}{4}$ R	4.5	740	6,600	7,340	.82	.0094	.207	.358	.870	17,100	790
8.0	8.75	$\frac{3}{4}$ R	4.5	860	6,930	7,790	.82	.0091	.200	.353	.872	17,500	790
8.5	9.0	$\frac{3}{4}$ R	4.5	990	7,270	8,260	.82	.0088	.194	.348	.874	17,900	795
9.0	9.25	$\frac{3}{4}$ R	4.5	1,140	7,560	8,700	.82	.0085	.188	.343	.877	18,200	795
9.5	9.5	$\frac{3}{4}$ R	6.0	1,300	7,890	9,190	.88	.0092	.188	.353	.873	17,900	810
10.0	9.75	$\frac{3}{4}$ R	6.0	1,470	8,180	9,650	.88	.0089	.182	.348	.875	18,200	810
11.0	10.0	$\frac{3}{4}$ R	5.5	1,820	8,770	10,590	.96	.0094	.177	.354	.874	17,800	810
12.0	10.5	$\frac{3}{4}$ R	7.0	2,250	9,330	11,580	1.03	.0095	.167	.356	.874	17,100	785
13.0	11.0	$\frac{3}{4}$ R	7.0	2,750	9,830	12,580	1.03	.0090	.158	.348	.878	17,500	780
14.0	11.5	$\frac{3}{4}$ R	7.0	3,310	10,330	13,640	1.03	.0086	.150	.341	.882	18,050	780
15.0	11.5	$\frac{3}{4}$ R	6.5	3,800	10,800	14,600	1.11	.0092	.150	.350	.879	18,000	805
16.0	12.0	$\frac{3}{4}$ R	6.0	4,480	11,270	15,750	1.20	.0095	.143	.353	.878	17,050	780
17.0	12.0	1R	7.5	5,060	11,700	16,760	1.26	.0100	.143	.358	.877	17,400	805
18.0	12.5	1R	7.5	5,870	12,090	17,960	1.26	.0095	.136	.352	.879	17,700	800
19.0	13.0	1R	7.5	6,770	12,490	19,260	1.26	.0091	.130	.346	.882	18,100	795
20.0	13.0	1R	7.0	7,500	12,850	20,350	1.35	.0098	.130	.354	.880	17,950	810
21.0	13.5	1R	7.0	8,550	13,200	21,750	1.35	.0094	.125	.348	.884	18,200	810
22.0	14.0	1R	6.5	9,680	13,570	23,250	1.45	.0097	.120	.352	.883	17,500	790
23.0	14.0	1R	6.0	10,900	13,900	24,490	1.57	.0105	.120	.361	.880	17,100	790
24.0	14.5	1R	6.0	11,870	14,210	26,080	1.57	.0101	.115	.356	.881	17,400	800
25.0	15.0	1R	6.0	13,280	14,500	27,780	1.57	.0097	.111	.351	.884	17,800	800

<sup>1</sup> See table 2 for reinforcement transverse to main reinforcement and table 9 for edge support requirements.

Case II.—Modified formulas will also be applied in the design of reinforced concrete bridge floor slabs with main reinforcement transverse to the direction of traffic.

The 1935 specifications of the American Association of State Highway Officials will be used, modified as follows:

Live-load moments computed by modified formulas as shown in table 18.

Unit stresses:  $f'_c = 3,000$  pounds per square inch;  $f_s = 18,000$  pounds per square inch;  $f_c = 800$  pounds per square inch;  $n = 12$ .

Live load: *H*-15 and *H*-20 truck train loading.

TABLE 18.—Summary of modified formulas for case II

Condition of slab at support	Spans (feet)	Live-load moments (In foot-pounds per foot width of slab)		Dead-load moment
		Exterior spans	Interior spans	
Freely supported.	0 to 4....	$M = \frac{P\sqrt{S}}{9.64}$	$M = \frac{P\sqrt{S}}{9.64}$	$\left. \begin{matrix} WS^2 \\ 8 \end{matrix} \right\}$
	4 to 10...	$M = \frac{PS}{2.32 S+10}$	$M = \frac{PS}{1.32 S+14}$	
Slabs continuous 50 percent end restraint.	0 to 4....	$M = \frac{P\sqrt{S}}{9.64} - 0.035P$	$M = \frac{P\sqrt{S}}{9.64} - 0.035P$	$\left. \begin{matrix} WS^2 \\ 10 \end{matrix} \right\}$
	4 to 10...	$M = \frac{PS}{2.32 S+10} - 0.035P$	$M = \frac{PS}{1.32 S+14} - 0.035P$	
Slabs monolithic 75 percent end restraint.	0 to 4....	$M = \frac{P\sqrt{S}}{9.64} - 0.0525P$	$M = \frac{P\sqrt{S}}{9.64} - 0.0525P$	$\left. \begin{matrix} WS^2 \\ 10 \end{matrix} \right\}$
	4 to 10...	$M = \frac{PS}{2.32 S+10} - 0.0525P$	$M = \frac{PS}{1.32 S+14} - 0.0525P$	
Fully restrained.	0 to 4....	$M = \frac{P\sqrt{S}}{9.64} - 0.07P$	$M = \frac{P\sqrt{S}}{9.64} - 0.07P$	$\left. \begin{matrix} WS^2 \\ 12 \end{matrix} \right\}$
	4 to 10...	$M = \frac{PS}{2.32 S+10} - 0.07P$	$M = \frac{PS}{1.32 S+14} - 0.07P$	

TABLE 19.—Live-load moments in foot-pounds per foot width of slab

Controlling conditions:  
 H-15 loading.  
 P=12,000 pounds.  
 Case II—transverse reinforcement.  
 Modified formulas  
 Freely supported.  
 Slabs continuous.  
 Slabs monolithic.  
 Fully restrained.

INTERIOR SPANS

Condition at support	Freely supported		Slabs continuous 50 percent end restraint		Slabs monolithic 75 percent end restraint		Fully restrained	
	Slab span S in feet	$I = \frac{50}{125+S}$	M	$M \times (1.0+I)$	M	$M \times (1.0+I)$	M	$M \times (1.0+I)$
2.0	0.394	1,760	2,450	1,340	1,870	1,130	1,575	1,285
2.5	.392	1,970	2,740	1,550	2,160	1,340	1,865	1,571
3.0	.391	2,160	3,005	1,740	2,420	1,530	2,130	1,835
3.5	.390	2,340	3,250	1,920	2,670	1,710	2,380	1,990
4.0	.388	2,490	3,460	2,070	2,875	1,860	2,580	2,290
4.5	.386	2,710	3,755	2,290	3,175	2,080	2,880	2,595
5.0	.385	2,910	4,030	2,490	3,450	2,280	3,160	2,870
5.5	.383	3,110	4,300	2,690	3,720	2,480	3,430	3,140
6.0	.382	3,280	4,530	2,860	3,950	2,650	3,660	3,370
6.5	.380	3,460	4,770	3,040	4,200	2,830	3,900	3,610
7.0	.379	3,610	4,980	3,190	4,400	2,980	4,110	3,820
7.5	.377	3,770	5,185	3,350	4,610	3,140	4,320	4,030
8.0	.376	3,910	5,380	3,490	4,800	3,280	4,510	4,220
8.5	.375	4,050	5,560	3,630	4,990	3,420	4,700	4,410
9.0	.373	4,170	5,720	3,750	5,150	3,540	4,860	4,590
9.5	.372	4,300	5,900	3,880	5,320	3,670	5,040	4,730
10.0	.370	4,410	6,040	3,990	5,470	3,780	5,180	4,890

EXTERIOR SPANS

2.0	0.394	1,760	2,450	1,340	1,870	1,130	1,575	922	1,285
2.5	.392	1,970	2,740	1,550	2,160	1,340	1,865	1,129	1,571
3.0	.391	2,160	3,005	1,740	2,420	1,530	2,130	1,318	1,835
3.5	.390	2,340	3,250	1,920	2,670	1,710	2,380	1,490	2,070
4.0	.388	2,490	3,460	2,070	2,875	1,860	2,580	1,650	2,290
4.5	.386	2,640	3,660	2,220	3,080	2,010	2,785	1,800	2,495
5.0	.385	2,780	3,850	2,360	3,270	2,150	2,980	1,940	2,685
5.5	.383	2,900	4,010	2,480	3,430	2,270	3,140	2,060	2,850
6.0	.382	3,010	4,160	2,590	3,580	2,380	3,290	2,170	3,000
6.5	.380	3,110	4,290	2,690	3,710	2,480	3,420	2,270	3,135
7.0	.379	3,200	4,410	2,780	3,830	2,570	3,540	2,360	3,260
7.5	.377	3,290	4,530	2,870	3,950	2,660	3,660	2,450	3,370
8.0	.376	3,360	4,620	2,940	4,050	2,730	3,760	2,520	3,470
8.5	.375	3,440	4,730	3,020	4,150	2,810	3,860	2,590	3,560
9.0	.373	3,500	4,810	3,080	4,230	2,870	3,940	2,660	3,650
9.5	.372	3,560	4,880	3,140	4,310	2,930	4,020	2,720	3,740
10.0	.370	3,620	4,960	3,200	4,380	2,990	4,100	2,770	3,790

Symbols are defined as follows:

S=Effective design span in feet.

W=Dead load per square foot of slab.

P=Wheel load=12,000 pounds for H-15 and 16,000 pounds for H-20 loading.

$I = \text{Impact factor} = \frac{50}{125+S}$

M=Maximum live-load moment.

$M(1.0+I)$ =Live load+impact moment.

$M_i$ =Design moment=Dead-load moment+  
 $M(1.0+I)$ .

All moments are in foot-pounds per foot width of slab.

For values of live-load moments in foot-pounds per foot width of slab by above formulas see tables 19 and 20.

For design moments, dimensions, and reinforcement of slabs for case II see tables 21 to 24.

TABLE 20.—Live-load moments in foot-pounds per foot width of slab

Controlling conditions:  
 H-20 loading.  
 P=16,000 pounds.  
 Case II—transverse reinforcement.  
 Modified formulas.  
 Freely supported.  
 Slabs continuous.  
 Slabs monolithic.  
 Fully restrained.

INTERIOR SPANS

Condition at support	Freely supported		Slabs continuous 50 percent end restraint		Slabs monolithic 75 percent end restraint		Fully restrained		
	Slab span S in feet	$I = \frac{50}{125+S}$	M	$M(1.0+I)$	M	$M(1.0+I)$	M	$M(1.0+I)$	
2.0	0.394	2,340	3,260	1,780	2,480	1,500	2,090	1,230	1,710
2.5	.392	2,620	3,650	2,060	2,870	1,780	2,480	1,505	2,100
3.0	.391	2,880	4,010	2,320	3,230	2,040	2,840	1,760	2,450
3.5	.390	3,110	4,320	2,550	3,540	2,270	3,150	1,985	2,760
4.0	.388	3,320	4,610	2,760	3,830	2,480	3,440	2,200	3,050
4.5	.386	3,610	5,000	3,050	4,230	2,770	3,840	2,497	3,460
5.0	.385	3,880	5,370	3,320	4,600	3,040	4,210	2,765	3,830
5.5	.383	4,150	5,740	3,590	4,970	3,310	4,580	3,028	4,190
6.0	.382	4,380	6,050	3,820	5,280	3,540	4,890	3,250	4,490
6.5	.380	4,610	6,360	4,050	5,590	3,770	5,200	3,490	4,820
7.0	.379	4,820	6,650	4,260	5,880	3,980	5,490	3,690	5,090
7.5	.377	5,030	6,930	4,470	6,160	4,190	5,770	3,900	5,370
8.0	.376	5,210	7,170	4,650	6,400	4,370	6,020	4,090	5,630
8.5	.375	5,400	7,420	4,840	6,660	4,560	6,270	4,270	5,870
9.0	.373	5,560	7,640	5,000	6,870	4,720	6,480	4,450	6,110
9.5	.372	5,730	7,860	5,170	7,100	4,890	6,710	4,600	6,340
10.0	.370	5,880	8,060	5,320	7,290	5,010	6,900	4,760	6,520

EXTERIOR SPANS

2.0	0.394	2,340	3,260	1,780	2,480	1,500	2,090	1,230	1,710
2.5	.392	2,620	3,650	2,060	2,870	1,780	2,480	1,505	2,100
3.0	.391	2,880	4,010	2,320	3,230	2,040	2,840	1,760	2,450
3.5	.390	3,110	4,320	2,550	3,540	2,270	3,150	1,985	2,760
4.0	.388	3,320	4,610	2,760	3,830	2,480	3,440	2,200	3,050
4.5	.386	3,520	4,880	2,960	4,100	2,680	3,710	2,400	3,330
5.0	.385	3,710	5,140	3,150	4,360	2,870	3,970	2,587	3,580
5.5	.383	3,870	5,350	3,310	4,580	3,030	4,190	2,747	3,800
6.0	.382	4,020	5,560	3,460	4,780	3,180	4,390	2,890	3,990
6.5	.380	4,150	5,730	3,590	4,960	3,310	4,570	3,026	4,180
7.0	.379	4,270	5,890	3,710	5,120	3,430	4,730	3,148	4,340
7.5	.377	4,380	6,030	3,820	5,260	3,540	4,870	3,267	4,500
8.0	.376	4,480	6,160	3,920	5,400	3,640	5,010	3,360	4,630
8.5	.375	4,580	6,300	4,020	5,530	3,740	5,140	3,450	4,740
9.0	.373	4,670	6,420	4,110	5,640	3,830	5,260	3,548	4,870
9.5	.372	4,750	6,520	4,190	5,750	3,910	5,360	3,625	4,970
10.0	.370	4,820	6,600	4,260	5,840	3,980	5,460	3,690	5,060

TABLE 21.—Design moments, dimensions, and reinforcement of slabs for the following conditions <sup>1</sup>

SLABS BEARING ON 3 OR MORE SUPPORTS AND CONTINUOUS OVER 2 OR MORE PANELS

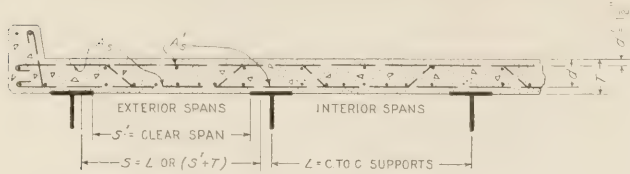

Spans 2 to 3.5 feet, inclusive,  $A'_s = A_s$ , bars not bent.  
Spans 4 to 10 feet, inclusive,  $A'_s = 0.5 A_s$ , bars bent as shown.

Controlling conditions:

- H-15 loading.
- Case II—transverse reinforcement.
- Slabs continuous.
- 50 percent end restraint.
- Paving allowance, 25 pounds per square foot.
- Modified formulas.
- $A_s$  = Area of tension reinforcement.
- $A'_s$  = Area of compression reinforcement.
- $d = T - 1.25$  inches for bars  $\frac{5}{8}$  inch or under.
- $d = T - 1.50$  inches for bars over  $\frac{5}{8}$  inch.
- All bars to be hooked at ends.

INTERIOR OR EXTERIOR SPANS

Slab span, S	Slab depth, T	Bar size	Bar space, center-to-center	Dead load moment, $\frac{WS^2}{10}$	M(1.0+I)	M <sub>t</sub>	A <sub>s</sub>	p	d'/d	k	j	Unit stress	
												f <sub>s</sub>	f <sub>c</sub>
Feet	Inches	Inch	Inches	Ft.-lb.	Ft.-lb.	Ft.-lb.	Sq. in.					Lb./sq. in.	Lb./sq. in.
2.0	5.25	1/2 R	6.5	40	1,870	1,910	0.36	0.0075	-----	0.344	0.886	17,950	785
2.5	5.5	1/2 R	6.0	60	2,160	2,220	.39	.0076	-----	.345	.885	18,150	800
3.0	5.75	1/2 R	5.5	90	2,420	2,510	.43	.0080	0.333	.349	.878	17,700	790
3.5	6.00	1/2 R	8.0	120	2,670	2,790	.46	.0082	.316	.349	.874	17,500	780
4.0	6.25	5/8 R	8.0	160	2,880	3,040	.46	.0077	.300	.342	.880	18,000	780
EXTERIOR SPANS													
4.5	6.25	5/8 R	7.0	210	3,080	3,290	0.53	0.0088	0.300	0.359	0.871	17,100	800
5.0	6.50	5/8 R	7.0	270	3,270	3,540	.53	.0084	.286	.352	.875	17,450	790
5.5	6.50	5/8 R	6.5	320	3,430	3,750	.57	.0090	.286	.361	.870	17,250	810
6.0	6.75	5/8 R	6.5	390	3,580	3,970	.57	.0086	.273	.353	.872	17,400	790
6.5	7.00	5/8 R	6.5	480	3,710	4,190	.57	.0079	.261	.347	.874	17,550	775
7.0	7.00	5/8 R	6.0	550	3,830	4,380	.61	.0088	.261	.355	.871	17,200	790
7.5	7.25	5/8 R	6.0	650	3,950	4,690	.61	.0085	.250	.350	.872	17,300	789
8.0	7.25	5/8 R	6.0	740	4,050	4,790	.61	.0085	.250	.350	.872	19,000	805
8.5	7.25	5/8 R	5.5	830	4,150	4,980	.67	.0093	.250	.361	.868	17,100	805
9.0	7.50	5/8 R	5.5	960	4,230	5,190	.67	.0089	.240	.355	.871	17,100	780
9.5	7.50	5/8 R	5.5	1,080	4,310	5,390	.67	.0089	.240	.355	.871	17,750	810
10.0	7.75	5/8 R	5.5	1,220	4,380	5,600	.67	.0086	.231	.349	.873	17,700	790
INTERIOR SPANS													
4.5	6.50	5/8 R	7.5	220	3,180	3,400	0.49	0.0078	0.286	0.343	0.879	18,050	785
5.0	6.50	5/8 R	6.5	270	3,450	3,720	.57	.0090	.286	.361	.870	17,200	810
5.5	6.75	5/8 R	6.5	330	3,720	4,050	.57	.0086	.273	.353	.872	17,750	810
6.0	7.00	5/8 R	6.5	400	3,950	4,350	.57	.0083	.261	.347	.874	18,200	805
6.5	7.25	5/8 R	6.0	496	4,200	4,690	.61	.0085	.250	.350	.872	17,600	790
7.0	7.25	5/8 R	5.5	570	4,400	4,970	.67	.0093	.250	.361	.868	17,100	805
7.5	7.50	5/8 R	5.5	670	4,610	5,280	.67	.0089	.240	.355	.871	17,400	800
8.0	7.75	5/8 R	5.5	780	4,800	5,590	.67	.0086	.231	.349	.873	17,600	785
8.5	7.75	5/8 R	5.0	880	4,990	5,870	.74	.0095	.231	.361	.868	16,900	795
9.0	8.00	5/8 R	5.0	1,010	5,160	6,160	.74	.0091	.222	.355	.871	17,000	780
9.5	8.25	5/8 R	5.0	1,160	5,320	6,480	.74	.0088	.214	.350	.873	17,200	770
10.0	8.25	5/8 R	5.0	1,280	5,470	6,750	.74	.0088	.214	.350	.873	17,900	800

<sup>1</sup> See tabulation, p. 155, for reinforcement transverse to main reinforcement.

TABLE 22.—Design moments, dimensions, and reinforcement of slabs for the following conditions <sup>1</sup>

SLABS BUILT MONOLITHIC WITH 3 OR MORE SUPPORTS AND CONTINUOUS OVER 2 OR MORE PANELS

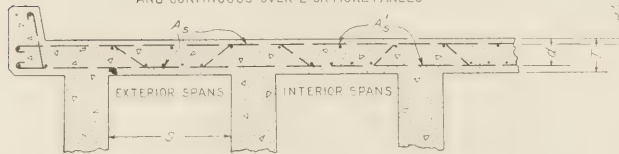

Spans 2 to 3.5 feet, inclusive,  $A'_s = A_s$ , bars not bent.  
Spans 4 to 10 feet, inclusive,  $A'_s = 0.5 A_s$ , bars bent as shown.

Controlling conditions:

- H-15 loading.
- Case II—transverse reinforcement.
- Slabs monolithic.
- 75 percent end restraint.
- Paving allowance 25 pounds per square foot.
- Modified formulas.
- $A_s$  = Area of tension reinforcement.
- $A'_s$  = Area of compression reinforcement.
- $d = T - 1.25$  inches for bars  $\frac{5}{8}$  inch or under.
- $d = T - 1.50$  inches for bars over  $\frac{5}{8}$  inch.
- All bars to be hooked at ends.

INTERIOR OR EXTERIOR SPANS

Slab span S	Slab depth T	Bar size	Bar space center-to-center	Dead load moment $\frac{WS^2}{10}$	M(1.0+I)	M <sub>t</sub>	A <sub>s</sub>	p	d'/d	k	j	Unit stress	
												f <sub>s</sub>	f <sub>a</sub>
Feet	Inches	Inch	Inches	Ft.-lb.	Ft.-lb.	Ft.-lb.	Sq. in.					Lb./sq. in.	Lb./sq. in.
2.0	5.00	1/2 R	7.0	35	1,575	1,610	0.34	0.0075	-----	0.344	0.886	17,100	750
2.5	5.25	1/2 R	6.5	60	1,865	1,925	.36	.0075	-----	.344	.886	18,000	790
3.0	5.50	1/2 R	6.0	90	2,130	2,220	.39	.0076	-----	.345	.885	18,100	800
3.5	5.75	1/2 R	5.5	120	2,380	2,500	.43	.0080	0.333	.349	.878	17,600	785
4.0	6.00	1/2 R	5.5	160	2,580	2,740	.43	.0075	.316	.342	.882	18,200	790

<sup>1</sup> See tabulation page 155 for reinforcement transverse to main reinforcement.

DESIGN 22.—Design moments, dimensions, and reinforcement of slabs for the following conditions—Continued

EXTERIOR SPANS

Slab span, <i>S</i>	Slab depth <i>T</i>	Bar size	Bar space center-to-center	Dead load moment $\frac{WS^2}{10}$	<i>M</i> (1.0+ <i>I</i> )	<i>M<sub>t</sub></i>	<i>A<sub>s</sub></i>	<i>p</i>	$\frac{d'}{d}$	<i>k</i>	<i>j</i>	Unit stress	
												<i>f<sub>s</sub></i>	<i>f<sub>c</sub></i>
Feet	Inches	Inch	Inches	Ft.-lb.	Ft.-lb.	Ft.-lb.	Sq. in.					Lb./sq. in.	Lb./sq. in.
4.5	6.00	5/8 R	7.5	265	2,785	2,990	0.49	0.0086	0.316	0.358	0.874	17,600	810
5.0	6.25	5/8 R	7.5	260	2,980	3,240	.49	.0082	.300	.350	.876	18,100	810
5.5	6.50	5/8 R	7.0	320	3,140	3,460	.53	.0084	.286	.352	.875	17,100	775
6.0	6.50	5/8 R	6.5	380	3,290	3,670	.57	.0090	.286	.361	.870	16,950	800
6.5	6.75	5/8 R	6.5	460	3,420	3,880	.57	.0086	.273	.353	.872	17,000	775
7.0	6.75	5/8 R	6.5	530	3,540	4,070	.57	.0086	.273	.353	.872	17,850	810
7.5	7.00	5/8 R	6.5	630	3,660	4,290	.57	.0083	.261	.347	.874	18,000	795
8.0	7.25	5/8 R	6.5	740	3,760	4,500	.57	.0079	.250	.341	.877	18,000	780
8.5	7.25	5/8 R	6.0	840	3,860	4,700	.61	.0085	.250	.350	.872	17,700	795
9.0	7.25	5/8 R	5.5	940	3,940	4,880	.67	.0093	.250	.360	.868	16,800	790
9.5	7.50	5/8 R	5.5	1,070	4,020	5,090	.67	.0089	.240	.355	.871	16,750	770
10.0	7.50	5/8 R	5.5	1,190	4,100	5,290	.67	.0089	.240	.355	.871	17,400	800

INTERIOR SPANS

4.5	6.25	5/8 R	7.5	210	2,880	3,090	0.49	0.0082	0.300	0.350	0.876	17,300	775
5.0	6.50	5/8 R	7.5	260	3,160	3,420	.49	.0078	.286	.343	.879	18,150	790
5.5	6.50	5/8 R	6.5	320	3,430	3,750	.57	.0090	.286	.361	.870	17,300	810
6.0	6.75	5/8 R	6.5	390	3,660	4,050	.57	.0086	.273	.353	.872	17,800	810
6.5	7.00	5/8 R	6.0	480	3,900	4,380	.61	.0088	.261	.355	.871	17,200	790
7.0	7.25	5/8 R	6.0	570	4,110	4,680	.61	.0085	.250	.350	.872	17,600	790
7.5	7.25	5/8 R	5.5	650	4,320	4,970	.67	.0093	.250	.361	.868	17,100	805
8.0	7.50	5/8 R	5.5	760	4,510	5,270	.67	.0089	.240	.355	.871	17,300	795
8.5	7.75	5/8 R	5.0	880	4,700	5,580	.74	.0086	.231	.349	.873	17,600	790
9.0	7.75	5/8 R	5.0	990	4,860	5,850	.74	.0095	.231	.361	.868	16,800	790
9.5	8.00	5/8 R	5.0	1,130	5,040	6,170	.74	.0091	.222	.355	.871	17,000	780
10.0	8.00	5/8 R	5.0	1,250	5,180	6,430	.74	.0091	.222	.355	.871	17,800	810

TABLE 23.—Design moments, dimensions, and reinforcement of slabs for the following conditions<sup>1</sup>

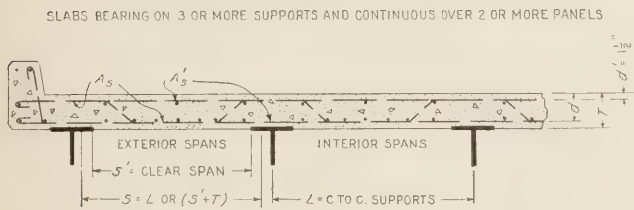

Spans 2 to 3.5 feet, inclusive,  $A'_s = A_s$ , bars not bent.  
Spans 4 to 10 feet, inclusive,  $A'_s = 0.5 A_s$ , bars bent as shown.

Controlling conditions:

*H*-20 loading.

Case II—transverse reinforcement.

Slabs continuous.

50 percent end restraint.

Paving allowance 25 pounds per square foot.

Modified formulas.

$A_s$  = Area of tension reinforcement.

$A'_s$  = Area of compression reinforcement.

$d = T - 1.25$  inches for bars 5/8 inch or under.

$d = T - 1.50$  inches for bars over 5/8 inch.

All bars to be hooked at ends.

INTERIOR OR EXTERIOR SPANS

Slab span <i>S</i>	Slab depth <i>T</i>	Bar size	Bar space center-to-center	Dead load moment $\frac{WS^2}{10}$	<i>M</i> (1.0+ <i>I</i> )	<i>M<sub>t</sub></i>	<i>A<sub>s</sub></i>	<i>p</i>	$\frac{d'}{d}$	<i>k</i>	<i>j</i>	Unit stress	
												<i>f<sub>s</sub></i>	<i>f<sub>c</sub></i>
Feet	Inches	Inch	Inches	Ft.-lb.	Ft.-lb.	Ft.-lb.	Sq. in.					Lb./sq. in.	Lb./sq. in.
2.0	5.75	1/2 R	5.5	40	2,480	2,520	0.43	0.0080	0.333	0.349	0.878	17,800	795
2.5	6.00	1/2 R	5.0	70	2,870	2,940	.47	.0082	.316	.349	.874	18,100	810
3.0	6.25	5/8 R	7.0	90	3,230	3,320	.53	.0088	.300	.354	.867	17,350	790
3.5	6.50	5/8 R	6.5	130	3,540	3,670	.57	.0090	.286	.353	.864	17,000	775
4.0	6.75	5/8 R	6.5	170	3,830	4,000	.57	.0086	.273	.353	.872	17,550	800
EXTERIOR SPANS													
4.5	7.00	5/8 R	6.5	230	4,100	4,330	0.57	0.0083	0.261	0.347	0.874	18,100	800
5.0	7.25	5/8 R	6.0	290	4,360	4,650	.61	.0085	.250	.350	.872	17,500	785
5.5	7.25	5/8 R	5.5	350	4,580	4,930	.67	.0093	.250	.361	.868	16,950	800
6.0	7.50	5/8 R	5.5	430	4,780	5,210	.67	.0089	.240	.355	.871	17,150	785
6.5	7.75	5/8 R	5.5	520	4,960	5,480	.67	.0086	.231	.349	.873	17,250	770
7.0	7.75	5/8 R	5.5	600	5,120	5,720	.67	.0086	.231	.349	.873	18,050	810
7.5	7.75	5/8 R	5.0	690	5,260	5,950	.74	.0095	.231	.361	.868	17,100	805
8.0	8.00	5/8 R	5.0	800	5,400	6,200	.74	.0091	.222	.355	.871	17,100	785
8.5	8.00	5/8 R	5.0	900	5,530	6,430	.74	.0091	.222	.355	.871	17,700	810
9.0	8.25	5/8 R	5.0	1,040	5,640	6,680	.74	.0088	.214	.350	.873	17,750	795
9.5	8.50	5/8 R	5.0	1,180	5,750	6,930	.74	.0085	.207	.345	.875	17,700	780
10.0	8.50	5/8 R	4.5	1,310	5,840	7,150	.82	.0094	.207	.358	.870	16,600	770
INTERIOR SPANS													
4.5	7.00	5/8 R	6.0	230	4,230	4,460	0.61	0.0089	0.261	0.357	0.871	17,550	810
5.0	7.25	5/8 R	5.5	290	4,600	4,890	.67	.0093	.250	.361	.868	16,800	790
5.5	7.50	5/8 R	5.5	360	4,970	5,330	.67	.0089	.240	.355	.871	17,500	800
6.0	7.75	5/8 R	5.5	440	5,280	5,720	.67	.0086	.231	.349	.873	18,050	805
6.5	8.00	5/8 R	5.0	530	5,590	6,120	.74	.0091	.222	.355	.871	16,900	775
7.0	8.25	5/8 R	5.0	630	5,880	6,510	.74	.0088	.214	.350	.873	17,250	775
7.5	8.25	5/8 R	4.5	720	6,160	6,880	.82	.0097	.214	.363	.868	16,600	790
8.0	8.50	5/8 R	4.5	840	6,400	7,240	.82	.0094	.207	.358	.870	16,800	780
8.5	8.75	5/8 R	4.5	970	6,660	7,630	.82	.0091	.200	.353	.872	17,050	775
9.0	8.75	5/8 R	4.5	1,090	6,870	7,960	.82	.0091	.200	.353	.872	17,800	810
9.5	9.00	5/8 R	4.5	1,240	7,100	8,340	.82	.0088	.194	.348	.875	17,950	800
10.0	9.25	5/8 R	4.5	1,410	7,290	8,700	.82	.0085	.188	.343	.877	18,100	790

<sup>1</sup> See tabulation p. 155 for reinforcement transverse to main reinforcement.

TABLE 24.—Design moments, dimensions, and reinforcement of slabs for the following conditions <sup>1</sup>

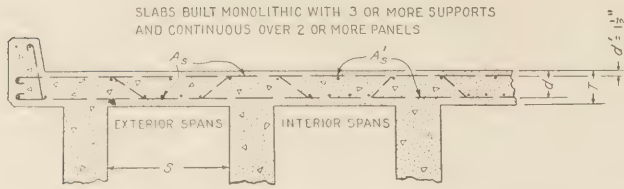

Slabs built monolithic with 3 or more supports and continuous over 2 or more panels.

Spans 2 to 3.5 feet, inclusive,  $A'_s = A_s$ , bars not bent.  
 Spans 4 to 10 feet, inclusive,  $A'_s = 0.5 A_s$ , bars bent as shown.

Controlling conditions:  
 H-20 loading.  
 Case II—transverse reinforcement.  
 Slabs monolithic.  
 75 percent end restraint.  
 Paving allowance, 25 pounds per square foot.  
 Modified formulas.  
 $A_s$  = Area of tension reinforcement.  
 $A'_s$  = Area of compression reinforcement.  
 $d = T - 1.25$  inches for bars  $\frac{3}{8}$  inch or under.  
 $d = T - 1.50$  inches for bars over  $\frac{3}{8}$  inch.  
 All bars to be hooked at ends.

INTERIOR OR EXTERIOR SPANS

Slab span S	Slab depth T	Bar size	Bar space center-to-center	Dead load moment $\frac{WS^2}{10}$	$M(1.0+I)$	$M_t$	$A_s$	$p$	$\frac{d'}{d}$	$k$	$j$	Unit stress	
												$f_s$	$f_c$
Feet	Inches	Inch	Inches	Ft.-lb.	Ft.-lb.	Ft.-lb.	Sq. in.					Lb./sq. in.	Lb./sq. in.
2.0	5.50	$\frac{1}{2}$ R	6.0	40	2,090	2,130	0.39	0.0076	0.333	0.345	0.885	17,400	770
2.5	5.75	$\frac{1}{2}$ R	5.5	60	2,480	2,540	.43	.0080	.316	.349	.878	17,950	800
3.0	6.00	$\frac{1}{2}$ R	5.0	90	2,840	2,930	.47	.0082	.316	.349	.874	18,000	805
3.5	6.25	$\frac{3}{4}$ R	7.0	130	3,150	3,280	.53	.0088	.300	.354	.865	17,200	790
4.0	6.50	$\frac{3}{4}$ R	7.0	170	3,440	3,610	.53	.0084	.286	.352	.875	17,800	810
EXTERIOR SPANS													
4.5	6.75	$\frac{3}{4}$ R	6.5	220	3,710	3,930	0.57	0.0086	0.273	0.353	0.872	17,250	785
5.0	7.00	$\frac{3}{4}$ R	6.5	280	3,970	4,250	.57	.0083	.261	.347	.874	17,800	790
5.5	7.25	$\frac{3}{4}$ R	6.5	350	4,190	4,540	.57	.0079	.250	.341	.877	18,000	780
6.0	7.25	$\frac{3}{4}$ R	6.0	420	4,390	4,810	.61	.0085	.250	.350	.872	18,100	810
6.5	7.50	$\frac{3}{4}$ R	6.0	500	4,570	5,070	.61	.0081	.240	.344	.875	18,200	795
7.0	7.50	$\frac{3}{4}$ R	5.5	580	4,750	5,310	.67	.0089	.240	.355	.871	17,500	800
7.5	7.75	$\frac{3}{4}$ R	5.5	690	4,870	5,560	.67	.0080	.231	.349	.873	17,550	785
8.0	7.75	$\frac{3}{4}$ R	5.0	780	5,010	5,790	.74	.0095	.231	.361	.868	16,600	785
8.5	7.75	$\frac{3}{4}$ R	5.0	880	5,140	6,020	.74	.0095	.231	.361	.868	17,300	810
9.0	8.00	$\frac{3}{4}$ R	5.0	1,010	5,260	6,270	.74	.0091	.222	.355	.871	17,300	795
9.5	8.25	$\frac{3}{4}$ R	5.0	1,160	5,360	6,520	.74	.0088	.214	.350	.873	17,300	780
10.0	8.25	$\frac{3}{4}$ R	5.0	1,280	5,460	6,740	.74	.0088	.214	.350	.873	17,850	800
INTERIOR SPANS													
4.5	6.75	$\frac{3}{4}$ R	6.5	220	3,840	4,060	0.57	0.0086	0.273	0.353	0.872	17,800	810
5.0	7.00	$\frac{3}{4}$ R	6.0	280	4,210	4,490	.61	.0088	.261	.356	.871	17,600	810
5.5	7.25	$\frac{3}{4}$ R	5.5	350	4,580	4,930	.67	.0093	.250	.361	.868	17,000	800
6.0	7.50	$\frac{3}{4}$ R	5.5	430	4,890	5,320	.67	.0089	.240	.355	.871	17,500	800
6.5	7.75	$\frac{3}{4}$ R	5.5	520	5,200	5,720	.67	.0086	.231	.349	.873	18,050	805
7.0	8.00	$\frac{3}{4}$ R	5.0	610	5,490	6,100	.74	.0091	.222	.355	.871	16,880	770
7.5	8.25	$\frac{3}{4}$ R	5.0	720	5,770	6,490	.74	.0088	.214	.350	.873	17,250	775
8.0	8.50	$\frac{3}{4}$ R	5.0	840	6,020	6,860	.74	.0085	.207	.345	.875	17,500	770
8.5	8.50	$\frac{3}{4}$ R	4.5	950	6,270	7,270	.82	.0094	.207	.358	.870	16,750	780
9.0	8.50	$\frac{3}{4}$ R	4.5	1,060	6,480	7,540	.82	.0094	.207	.358	.870	17,500	810
9.5	8.75	$\frac{3}{4}$ R	4.5	1,210	6,710	7,920	.82	.0091	.200	.353	.872	17,700	800
10.0	9.00	$\frac{3}{4}$ R	4.5	1,380	6,900	8,280	.82	.0088	.194	.348	.874	17,900	800

<sup>1</sup> See tabulation p. 155 for reinforcement transverse to main reinforcement.

Part 4.—EXAMPLES OF SLAB DESIGN BY MODIFIED FORMULAS

The following examples of slab designs are given in order to illustrate the application of the modified formulas and tables advanced in this analysis.

*Example 1.*—Required: To design a bridge floor slab of uniform thickness, providing a 24-foot clear roadway for *H-15* loading, with main reinforcement transverse to the direction of traffic.

The size and spacing of the supporting stringers will depend on the bridge span and for this example are assumed to be as shown by figure 13. The stringer flanges in figure 13 are assumed to be 12 inches wide.

The effective design span *S* is shown by the figure at the top of table 21 to be the clear span *S'* plus total slab depth *T*, or  $S=S'+T$ . Trial slab depths for the above spans are shown in table 21 for 50 percent end restraint to be 6¼ inches for exterior spans and 7 inches for interior spans.

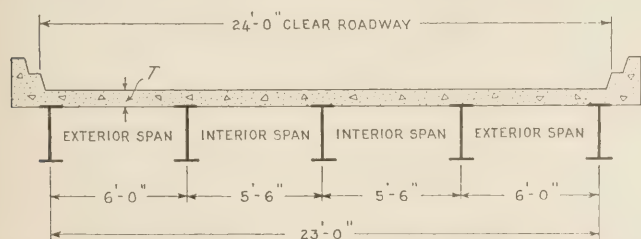

FIGURE 13.—BRIDGE SPAN AND SPACING OF STRINGERS ASSUMED FOR EXAMPLE 1.

Using the above trial slab depths and solving for the effective design span *S* results in the following slabs:

Exterior spans:  $S=(6 \text{ feet})-12 \text{ inches}+6\frac{1}{4} \text{ inches}=5 \text{ feet } 6\frac{3}{4} \text{ inches}$ .

Slab required from table 21:  $T=6\frac{1}{2} \text{ inches}$  and  $A_s=5/8\text{-inch}$  diameter bars at 6.5-inch centers=0.57 square inches.

Interior spans:  $S=(5 \text{ feet } 6 \text{ inches})-12 \text{ inches}+7 \text{ inches}=5 \text{ feet } 1 \text{ inch}$ .

Slab required from table 21:  $T=6\frac{1}{2} \text{ inches}$  and  $A_s=5/8\text{-inch}$  diameter bars at 6.5-inch centers=0.57 square inches.

Reinforcement required in the bottom of the slab in the direction of the *y*-axis, from the tabulation on page 155:

Middle half of slab span:  $A_s=65 \text{ percent of } 0.57=0.37 \text{ square inches}=5/8\text{-inch}$  diameter bars at 10-inch centers.

Outer quarters of slab span:  $A_s=45 \text{ percent of } 0.57=0.27 \text{ square inches}=5/8\text{-inch}$  diameter bars at 13½-inch centers.

Where stringers are of uniform spacing and the slab is of uniform thickness the design of the slab is determined by the requirements for interior spans.

In the design of bridge floor slabs for case II, where the slabs are monolithic with the supporting beams, the procedure is similar to that followed in example 1 except that the clear span between supports is used as the design span of slab.

*Example 2.*—Required: To design a bridge floor slab of uniform thickness providing a 24-foot clear roadway for *H-15* loading, with main reinforcement parallel to the direction of traffic.

It is assumed that the slab is supported on at least three *I*-beams, the beams having flanges 12 inches wide and spaced at 15-foot centers.

Under the conditions assumed above, it will be found that the effective design span is 15 feet and for this span, table 12, 50 percent end restraint shows the required slab thickness,  $T=11 \text{ inches}$  and the main reinforcement  $A_s=1.03 \text{ square inches}=7/8\text{-inch}$  diameter bars at 7-inch centers.

Reinforcement required in bottom of slab in direction of *y*-axis, from table 2:

Middle half of span: 35 percent of 1.03 square inches = 0.36 square inches = 5/8-inch diameter bars at 10-inch centers.

Outer quarters of span: 25 percent of 1.03 square inches = 0.26 square inches 5/8-inch diameter bars at 14-inch centers.

Table 7 shows that for a 15-foot span, with 50 percent end restraint, the edge supports must provide for live load plus impact moments  $M_E(1.0+I)=29,280 \text{ foot-pounds}$ . To this live-load moment must be added the dead-load moment of edge support and the design then completed as for an ordinary concrete beam.

It will be found that generally a properly proportioned curb and that section of the floor slab directly below the curb, with proper reinforcement, will together provide an edge support of adequate strength.

HIGHWAY RESEARCH BOARD TO MEET SOON

The Seventeenth Annual Meeting of the Highway Research Board of the National Research Council will be held in Washington, D. C., Tuesday, November 30 to Friday, December 3, 1937. Reports on highway research investigations will be presented. This year the

formal meeting of the Board will be interspersed with open meetings for informal discussion of pertinent topics. A program of reports is to be announced in the near future.

STATUS OF FEDERAL-AID HIGHWAY PROJECTS

AS OF SEPTEMBER 30, 1937

STATE	COMPLETED DURING CURRENT FISCAL YEAR			UNDER CONSTRUCTION			APPROVED FOR CONSTRUCTION			BALANCE OF FUNDS AVAILABLE FOR PROJECTS
	Estimated Total Cost	Federal Aid	Miles	Estimated Total Cost	Federal Aid	Miles	Estimated Total Cost	Federal Aid	Miles	
Alabama	\$ 493,737	\$ 352,427	26.3	\$ 1,904,861	\$ 952,430	81.2	\$ 3,892,490	\$ 1,946,240	180.2	\$ 4,948,510
Arizona	951,061	951,061	49.4	1,674,618	1,207,502	62.9	387,064	246,827	13.5	1,496,273
Arkansas				2,987,580	2,981,461	206.9	264,896	264,568	13.4	2,201,562
California	4,130,314	2,176,652	89.3	6,115,326	3,339,231	99.4	1,591,714	850,109	32.3	2,545,078
Colorado	2,120,146	1,184,994	80.3	1,374,756	759,648	41.0	297,633	151,302	1.5	2,275,521
Connecticut	433,578	214,586	4.6	508,530	246,433	5.3	72,610	36,300		1,513,584
Delaware	145,000	72,500	5.3	357,312	183,567	14.2	243,905	119,934	14.8	1,107,687
Florida	134,650	67,320	6.6	2,886,732	1,443,366	66.8	397,670	198,835	6.5	2,701,380
Georgia	1,296,635	648,307	74.8	3,960,707	1,860,786	184.8	1,526,786	793,333	62.1	5,240,708
Idaho	1,355,247	809,466	118.3	1,388,134	829,769	86.7	295,051	151,329	16.5	1,175,308
Illinois	3,269,564	1,600,307	95.9	9,444,533	4,701,925	298.6	4,942,023	2,464,300	77.2	2,194,856
Indiana	1,958,389	973,305	33.5	2,036,618	2,518,188	147.8	1,441,072	720,756	28.4	2,110,500
Iowa	3,368,384	1,545,380	105.4	6,538,400	2,911,416	192.5	1,344,990	604,627	48.7	1,023,707
Kansas	1,571,591	758,540	97.9	4,696,994	2,348,398	174.1	1,867,742	933,869	98.2	3,290,233
Kentucky	476,246	238,123	11.1	4,110,237	2,005,119	117.6	1,667,898	833,949	96.6	2,580,372
Louisiana	213,312	102,519	5.9	6,753,832	1,500,885	48.6	5,293,838	836,455	12.5	1,740,479
Maine	946,670	473,335	28.6	2,162,366	1,081,183	54.2	947,940	473,970	18.3	250,269
Maryland	180,456	90,228	2.1	1,585,150	792,542	26.3	842,318	421,159	12.2	1,790,879
Massachusetts	387,641	193,820	3.2	4,574,608	2,287,304	19.3	111,392	55,656	46.6	2,561,513
Michigan	3,623,700	1,811,850	97.1	6,720,410	3,360,705	163.0	2,745,879	1,294,714	46.6	2,494,212
Minnesota	2,474,120	1,228,319	123.5	4,768,060	2,313,416	177.9	2,224,570	779,760	89.6	1,794,472
Mississippi	472,300	236,150	22.7	4,305,190	2,152,430	209.8	2,209,100	1,102,750	86.4	3,441,846
Missouri	4,030,612	1,973,986	203.8	6,827,637	3,290,264	295.9	3,796,529	1,566,545	102.7	2,005,637
Montana	2,413,790	1,253,022	179.0	2,407,497	1,222,078	139.7	752,714	408,031	27.1	2,355,546
Nebraska	1,148,631	574,315	108.7	5,023,735	2,531,230	510.1	2,457,254	567,243	59.8	2,458,943
Nevada	913,415	783,466	63.3	1,759,200	1,521,487	57.6	116,897	101,370	15.0	963,072
New Hampshire	143,483	71,379	1.9	666,718	329,127	11.2				1,032,363
New Jersey	1,813,138	1,115,241	135.8	2,497,729	1,171,249	22.2	18,550	9,275	60.9	2,291,806
New Mexico	4,449,714	2,004,726	67.3	2,507,324	1,628,618	123.8	946,882	577,521	323.532	323,532
New York	1,682,619	841,250	114.9	19,063,681	9,091,106	325.9	3,743,980	1,834,430	59.8	1,040,960
North Carolina	696,200	556,200	125.4	4,898,694	2,307,247	304.4	2,203,818	980,139	67.1	2,976,231
North Dakota	1,036,282	541,498	50.4	765,740	745,230	118.6	398,912	398,912	56.3	3,921,891
Ohio	1,356,190	712,093	17.5	9,586,100	4,700,014	106.1	2,312,460	1,156,230	26.3	5,688,182
Oklahoma	1,827,166	1,110,135	85.7	3,391,256	1,759,570	143.0	1,787,641	937,843	83.5	3,264,447
Oregon	4,467,081	2,225,990	60.0	2,919,130	1,137,784	84.5	549,140	315,006	25.7	1,200,809
Pennsylvania	576,250	266,814	5.7	11,104,713	5,538,585	156.1	2,445,464	1,188,621	43.5	3,804,702
Rhode Island	1,716,535	702,700	137.4	1,095,487	547,734	13.7	235,360	117,690	1.7	772,483
South Carolina	1,222,122	727,296	82.4	4,658,992	1,885,758	228.0	1,921,048	743,335	72.8	1,500,411
South Dakota	739,218	360,664	31.3	2,102,240	1,167,856	230.0	522,978	289,160	72.5	3,387,450
Tennessee	5,055,162	2,525,140	398.6	1,967,844	783,922	44.6	995,620	497,810	37.8	4,877,275
Texas	300,225	215,894	21.7	9,844,999	4,004,555	508.9	3,926,376	1,947,043	192.2	6,954,421
Utah	664,181	322,733	18.1	1,564,033	1,112,421	145.2	234,270	163,350	14.5	1,095,388
Vermont	1,460,880	730,440	80.7	1,196,520	531,579	31.5	618,288	249,409	16.7	149,111
Virginia	1,036,527	576,500	57.5	2,895,938	1,308,679	71.5	1,460,592	712,161	54.2	2,166,446
Washington	528,936	264,468	15.4	2,902,159	1,517,879	47.8	332,792	171,300	4.0	1,223,763
West Virginia	5,035,283	2,362,245	136.5	1,514,074	756,130	43.3	642,490	439,445	15.9	2,227,236
Wisconsin	1,471,229	896,956	142.5	6,459,155	3,136,120	204.0	409,575	203,400	18.9	1,433,196
Wyoming				1,752,254	1,063,914	215.0	437,010	265,990	36.6	355,249
District of Columbia										
Hawaii										
Puerto Rico										
TOTALS	76,276,289	39,875,285	3,431.4	195,139,402	96,532,330	6,671.5	68,577,788	31,477,030	2,132.2	108,921,987



# CURRENT STATUS OF UNITED STATES WORKS PROGRAM HIGHWAY PROJECTS

(AS PROVIDED BY THE EMERGENCY RELIEF APPROPRIATION ACT OF 1935)

AS OF SEPTEMBER 30, 1937

STATE	APPORTIONMENT		COMPLETED		UNDER CONSTRUCTION		APPROVED FOR CONSTRUCTION		BALANCE OF FUNDS AVAILABLE FOR NEW PROJECTS
	Estimated Total Cost	Works Program Funds	Miles	Estimated Total Cost	Works Program Funds	Miles	Estimated Total Cost	Works Program Funds	
Alabama	\$ 4,151,115	\$ 3,689,902	134.1	\$ 439,718	\$ 439,718	10.6			\$ 59,045
Arizona	2,569,841	3,120,812	194.8	43,485	43,485				77,522
Arkansas	3,352,061	3,099,822	338.8	225,432	224,123	21.4			47,204
California	7,747,928	7,545,686	257.5	572,929	515,656	6.4			37,561
Colorado	3,395,263	2,459,381	101.0	89,597	89,596	6.0			838,086
Connecticut	1,418,709	940,745	14.5	463,940	422,110	8.0			42,270
Delaware	900,310	605,917	48.9	278,892	278,892	17.9			41,233
Florida	2,597,144	2,560,805	98.2	65,157	65,157	.9			35,890
Georgia	4,988,967	1,123,540	74.7	1,109,384	2,067,950	115.3	1,276,064	1,155,064	661,469
Idaho	2,222,747	2,151,909	185.6	49,205	49,131	.3			21,707
Illinois	8,694,009	7,973,079	449.6	826,743	826,743	38.4			102,446
Indiana	4,941,255	4,651,000	196.7	545,867	504,767	41.7			25,629
Iowa	4,991,664	5,092,889	525.5	203,697	202,094	2.8			4,700
Kansas	4,994,975	4,301,433	347.3	693,749	651,577	34.5			72,991
Kentucky	3,228,797	3,128,797	348.3	459,839	459,839	9.6			57,000
Louisiana	2,890,429	2,167,717	157.0	660,493	599,816	10.7			24,724
Maine	1,676,799	1,487,034	68.9	177,147	177,147	7.2			48,194
Maryland	1,750,738	612,216	20.8	606,836	606,836	14.2			379,160
Massachusetts	3,262,885	398,411	4.2	2,609,126	2,218,356	14.2			71,525
Michigan	6,301,414	5,940,287	287.1	303,037	301,921	4.8			25,324
Minnesota	5,277,145	5,995,874	888.4	476,734	269,135	14.2			8,886
Mississippi	3,457,592	2,799,627	194.5	574,998	573,958	41.1			108,067
Missouri	6,012,652	5,076,063	772.2	1,024,997	904,435	5.5			9,668
Montana	3,676,416	3,434,392	192.8	278,930	237,591	9.9			11,467
Nebraska	3,870,739	3,218,185	339.0	658,455	684,451	31.4			419
Nevada	2,283,074	2,289,662	110.1	33,646	33,646	2.5			37,746
New Hampshire	945,225	871,786	37.7	67,367	67,367				40,344
New Jersey	3,129,805	1,060,345	16.8	2,038,819	2,025,664	18.6			9,705
New Mexico	2,871,397	2,620,712	196.8	233,950	233,950	16.8			510,157
New York	11,046,377	10,520,284	167.4	375,889	375,889	2.7			19,077
North Carolina	4,720,173	4,004,967	258.6	727,882	727,281	32.0			19,810
North Dakota	2,667,245	2,484,477	378.9	112,995	112,899	1.2			64,000
Ohio	7,670,815	5,873,697	231.2	1,749,607	1,709,557	62.1			10,871
Oklahoma	4,580,670	4,193,456	387.6	454,326	454,326	17.6			41,992
Oregon	3,038,642	3,127,168	161.0	134,854	134,854	3.6			143,970
Pennsylvania	9,347,797	3,221,797	155.8	5,741,748	5,327,526	105.0			72
Rhode Island	989,208	1,109,360	18.8	2,240	2,240				33,999
South Carolina	2,702,012	2,662,013	224.6	627,419	545,752	24.9			16,346
South Dakota	2,376,494	2,420,331	450.7	543,257	543,257	53.9			7,489
Tennessee	4,192,460	2,882,289	118.1	1,201,513	1,201,513	30.4			27,356
Texas	11,989,350	12,606,777	1,105.8	382,509	285,584	5.9			4,858
Utah	2,067,154	2,044,610	204.2	196,775	196,775	4.5			19,468
Vermont	924,306	1,016,161	21.9	49,422	36,400	1.3			4,385
Virginia	3,652,667	3,304,947	1,009.3	217,653	214,356	23.8			5,595
Washington	3,056,161	3,315,317	163.4	85,272	85,272	.9			54,644
West Virginia	2,231,412	1,364,296	58.7	972,482	836,584	36.5			
Wisconsin	4,823,884	5,250,257	343.4	94,268	93,900	.3			
Wyoming	2,219,155	2,185,929	152.4	33,287	33,287				
District of Columbia	949,496	950,000	8.8	949,496	949,496				
Hawaii	926,033	623,701	8.9	623,701	623,701	8.5			
TOTALS	195,000,000	166,349,979	12,231.9	30,961,875	28,929,152	920.0	5,259,475	4,102,499	4,104,935

# CURRENT STATUS OF UNITED STATES WORKS PROGRAM GRADE CROSSING PROJECTS

(AS PROVIDED BY THE EMERGENCY RELIEF APPROPRIATION ACT OF 1935)

AS OF SEPTEMBER 30, 1937

STATE	APPORTIONMENT	COMPLETED			UNDER CONSTRUCTION			APPROVED FOR CONSTRUCTION			BALANCE OF FUNDS AVAILABLE FOR NEW PROJECTS
		Estimated Total Cost	Works Program Funds	NUMBER	Estimated Total Cost	Works Program Funds	NUMBER	Estimated Total Cost	Works Program Funds	NUMBER	
Alabama	\$ 4,034,617	\$ 3,037,998	\$ 3,020,448	42	\$ 862,072	\$ 862,072	7	\$ 185,100	\$ 108,800	4	\$ 23,297
Arizona	1,256,099	1,113,686	1,079,056	13	185,468	165,059	2	6,403	6,403	2	7,561
Arkansas	3,574,060	2,754,944	2,748,164	48	634,348	633,513	7	160,617	160,347	1	32,036
California	7,486,362	6,603,168	6,384,827	38	1,082,369	1,079,589	9	10,000	10,000	5	11,046
Colorado	2,631,567	1,462,997	1,400,633	19	881,188	881,188	9	377,010	339,301	3	10,444
Connecticut	1,712,684	297,379	297,379	2	1,341,801	1,320,440	8				94,665
Delaware	418,239	130,000	130,000	1	277,993	277,993	2				10,246
Florida	2,827,883	2,181,925	2,178,863	26	342,524	341,918	5	132,520	132,520	73	174,562
Georgia	4,895,949	282,327	250,835	19	1,369,471	1,369,471	28	808,650	808,650	10	2,466,993
Illinois	1,674,479	1,261,332	1,253,853	19	396,821	396,731	4	4,921	4,921	4	18,974
Indiana	10,307,184	7,753,806	7,706,056	60	2,368,150	2,368,150	13	226,000	226,000	2	6,378
Iowa	5,111,096	3,582,911	3,424,333	30	1,625,266	1,625,266	10	80,407	80,407	1	12,799
Kansas	5,600,679	4,128,087	4,041,559	92	1,480,254	1,477,631	17	108,004	15,000	2	15,000
Kentucky	5,246,298	4,000,835	3,939,399	54	2,127,119	2,253,704	4	573,365	573,365	1	52,606
Kentucky	3,672,387	1,195,369	1,187,927	16	2,148,221	1,858,489	8	842,856	775,566	7	81,330
Louisiana	3,213,467	1,260,353	1,260,353	13	1,096,237	1,096,219	11	4,380	4,380	1	28,190
Maine	1,426,861	1,069,183	1,066,911	15	375,052	327,380	1	590,362	517,893	4	282,449
Maryland	2,061,751	501,739	501,739	3	759,670	759,670	5	249,991	249,991	1	216,060
Massachusetts	4,210,133	2,035,116	2,035,031	17	1,709,751	1,709,751	9	43,500	43,500	1	59,669
Michigan	6,765,197	5,983,269	5,767,480	43	969,077	896,608	9	11,131	11,131	1	11,131
Minnesota	5,395,441	4,190,471	4,095,559	47	1,293,905	1,288,752	9	77,000	77,000	2	19,660
Mississippi	3,241,475	1,836,581	1,836,117	42	819,408	819,408	13	1,650	1,650	1	19,660
Missouri	6,142,153	2,337,883	2,274,385	34	3,976,810	3,842,459	25	1,650	1,650	1	2,376
Montana	2,782,327	2,621,142	2,574,020	27	245,576	185,931	1	219,670	194,632	5	26,046
Nebraska	3,556,441	2,659,232	2,622,097	73	713,266	713,266	8	3,630	3,630	5	12,905
Nevada	887,260	885,084	871,417	6	13,308	13,308	4	11,508	11,508	2	
New Hampshire	522,484	543,076	543,031	6	292,094	267,545	4	44,730	44,730	1	53,563
New Jersey	3,983,826	1,368,744	1,357,699	12	2,527,814	2,527,814	12	94,000	94,000	1	171,189
New Mexico	1,725,286	1,647,440	1,637,999	18	82,384	82,384	1	431,270	431,270	4	101,350
New York	13,577,189	9,429,245	9,154,721	30	4,151,280	4,151,280	15	94,000	94,000	1	171,189
North Carolina	4,823,936	3,087,524	3,082,898	42	1,223,939	1,208,439	16	431,270	431,270	4	101,350
North Dakota	3,207,473	2,227,259	2,223,856	45	983,486	983,486	11	963,579	932,874	13	192,225
Ohio	8,439,837	1,790,539	1,681,388	12	6,090,644	5,627,411	34	202,170	202,170	1	18,050
Oklahoma	5,004,713	3,448,816	3,441,297	54	1,476,294	1,343,194	11	202,170	202,170	1	17,878
Oregon	2,334,204	2,239,057	2,154,389	15	6,874,415	6,336,082	30	150,473	150,473	5	287,202
Pennsylvania	11,483,513	5,051,439	4,649,856	56	1,441,314	1,441,314	7	308,011	308,011	1	2,683
Rhode Island	699,691	653,760	652,694	4	44,314	44,314	3	211,477	211,477	1	308,011
South Carolina	3,059,956	1,561,919	1,562,028	28	1,205,870	1,198,439	17	211,477	211,477	1	308,011
South Dakota	3,249,086	2,040,762	2,040,075	40	991,229	931,229	25	269,350	210,393	17	7,390
Tennessee	3,903,979	1,164,324	1,154,641	3	2,238,300	2,238,340	22	250,230	250,230	1	260,768
Texas	10,855,982	9,409,434	9,402,105	123	786,800	786,797	4	372,155	360,311	1	306,769
Utah	1,230,763	930,600	929,195	12	290,423	290,423	5	159,260	157,246	2	8,744
Vermont	729,897	560,407	533,839	7	204,133	187,274	3	159,260	157,246	2	8,744
Virginia	3,774,287	2,347,895	2,238,024	39	1,375,798	1,369,173	11	4,582	4,582	3	9,443
Washington	3,055,041	2,153,830	2,143,602	21	640,156	639,126	20	27,947	27,947	2	21,151
West Virginia	2,577,937	4,054,169	4,054,169	3	308,846	2,306,878	20	68,667	68,667	19	1,950
Wisconsin	1,560,841	1,164,879	1,164,770	12	189,365	189,365	2				6,706
Wyoming	417,779	417,779	410,804	3	226,162	158,370	2				2,556
Dist. of Columbia	453,703	293,667	292,776	3							
Hawaii											
TOTALS	196,000,000	123,155,101	120,761,189	1468	63,609,367	61,707,904	465	7,967,414	7,440,797	94	6,090,110



